

ITSU
御手の物®





Product User Manual

IS6028

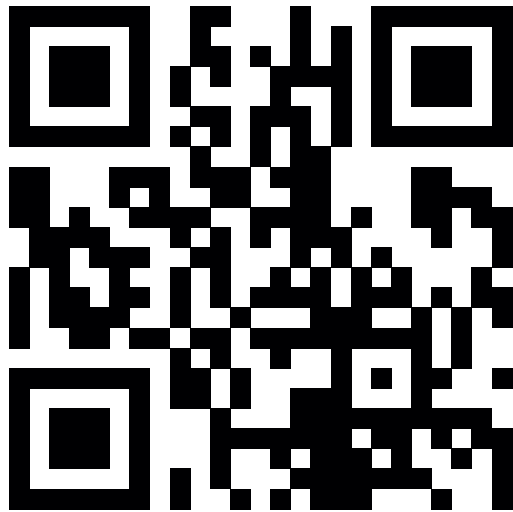

Please scan to download
Help to save the environment

Contents

Before Use

- Important safety instructions EN1
- Grounding instructions EN5
- Product parts EN6
- Before use EN7

How to Use

- Operation Instruction EN10
- After massage EN16

Maintenance

- Cleaning and maintenance EN17

Q&A/Important notes



- Q&A EN18
- Troubleshooting EN19
- Specification EN21
- Contact Us EN23

Important safety instructions

Must be followed



These safety instructions must be strictly followed in use to avoid personal injuries and property damage are as follows:

■ All the safety instructions are described in compliance with degrees of the injuries or damage as a result of wrong use.

| | |
|---|--|
|  Warning | Actions tending to cause serious injuries or death |
|  Caution | Actions tending to cause minor injuries or property damage |



■ Pay attention to the symbols before safety instructions (an example is given below).

| | |
|---|---|
|  Actions that must be absolutely forbidden |  Actions that must be done |
|---|---|

|  Warning | | | |
|---|--|--|--|
|  Must be followed | <ul style="list-style-type: none"> ● Before using the product, persons who are being treated or have any of the following symptoms should consult a physician. <table border="0" style="width: 100%;"> <tr> <td style="width: 50%; vertical-align: top;"> (1) Persons with a pacemaker or another in-vivo electronic medical device tending to suffer electronic jamming; (2) Patients with malignant tumors; (3) Patients with heart disease; (4) Persons proved to be unable to identify temperatures; (5) Pregnant persons or women who have just had childbirth; (6) Persons with perceptual disturbance because of diabetes or another serious peripheral circulation disturbance; (7) Osteoporosis patients, spinal fracture patients, or persons with acute painful diseases such as sprains or muscle strains; </td> <td style="width: 50%; vertical-align: top;"> (8) Persons with injuries in the massaged parts; (9) Persons with a body temperature above 38 °C (with a fever) (For example, persons with intense acute inflammation symptoms such as listlessness, cold shivers and blood pressure change or persons in poor health); (10) Persons who are unwell or must have a rest; (11) Persons with an abnormal or bent vertebra; (12) Persons with protrusion of intervertebral disc; (13) Persons who feel very uncomfortable (except for the circumstances above) </td> </tr> </table> <p>Otherwise accidents or physical discomfort may happen.</p> ● If you feel physically abnormal while using or no effect after use, stop the product immediately and consult a physician about it. Otherwise accidents or physical discomfort may happen. ● Do not massage for more than 30 minutes each time. ● Do not massage a single part for more than 5 minutes. If any of these safety instructions is not followed, you may suffer an adverse effect and be injured. ● After use each time, turn the power switch to the “O” position, and then pull out the power plug. Otherwise accidents or injuries may happen due to naughty behaviors of children. ● Follow the regulations about use of the socket and the wiring devices. ● Use a 220-240V~, 50/60Hz power supply. (Do not use the product in a foreign country or connect it with a transformer without permission.) Otherwise electric shocks, product faults or fires because of overheat may happen. ● Insert the power plug thoroughly into the socket. Otherwise electric shocks or fires caused by overheat may happen. ● Remove such dirt as dust on the power plug at regular intervals. Otherwise fires caused by poor insulation due to factors such as moisture may happen. (Wipe the power plug with dry cloth.) | (1) Persons with a pacemaker or another in-vivo electronic medical device tending to suffer electronic jamming; (2) Patients with malignant tumors; (3) Patients with heart disease; (4) Persons proved to be unable to identify temperatures; (5) Pregnant persons or women who have just had childbirth; (6) Persons with perceptual disturbance because of diabetes or another serious peripheral circulation disturbance; (7) Osteoporosis patients, spinal fracture patients, or persons with acute painful diseases such as sprains or muscle strains; | (8) Persons with injuries in the massaged parts; (9) Persons with a body temperature above 38 °C (with a fever) (For example, persons with intense acute inflammation symptoms such as listlessness, cold shivers and blood pressure change or persons in poor health); (10) Persons who are unwell or must have a rest; (11) Persons with an abnormal or bent vertebra; (12) Persons with protrusion of intervertebral disc; (13) Persons who feel very uncomfortable (except for the circumstances above) |
| | (1) Persons with a pacemaker or another in-vivo electronic medical device tending to suffer electronic jamming; (2) Patients with malignant tumors; (3) Patients with heart disease; (4) Persons proved to be unable to identify temperatures; (5) Pregnant persons or women who have just had childbirth; (6) Persons with perceptual disturbance because of diabetes or another serious peripheral circulation disturbance; (7) Osteoporosis patients, spinal fracture patients, or persons with acute painful diseases such as sprains or muscle strains; | (8) Persons with injuries in the massaged parts; (9) Persons with a body temperature above 38 °C (with a fever) (For example, persons with intense acute inflammation symptoms such as listlessness, cold shivers and blood pressure change or persons in poor health); (10) Persons who are unwell or must have a rest; (11) Persons with an abnormal or bent vertebra; (12) Persons with protrusion of intervertebral disc; (13) Persons who feel very uncomfortable (except for the circumstances above) | |



Important safety instructions

Must be followed

|  Warning | |
|---|---|
|  Must be followed | <ul style="list-style-type: none"> ● In the case of any abnormality or fault, stop the product immediately and pull out the power plug to avoid smoke, fires and electric shocks. Abnormality and fault examples <ul style="list-style-type: none"> • The product fails to work after the power switch is turned to the ON position; • After the power line is moved, the product is discontinuously powered on; • In use, the product gives off a burning smell or an abnormal sound; • The product is deformed or abnormally heating; → In any of these abnormalities and faults, have the product inspected and repaired by an authorized service center immediately. |
|  Forbidden | <ul style="list-style-type: none"> ● When handling the product, hold its frame. Otherwise product faults or personal injuries may happen. ● The following persons should not use the product. Persons for whom massage is forbidden by doctors, such as persons with thrombosis, serious aneurysm, acute venous aneurysm, various skin inflammations (such as subcutaneous tissue inflammation) or various skin infections. Otherwise diseases may get worse. ● The following persons should not massage their waists. <ul style="list-style-type: none"> • Persons with acute lumbago, protrusion of intervertebral disc, or displacement of a lumbar vertebra; • Persons with deformation or other discomfort of the hip joint; Otherwise diseases may get worse. |
| | <ul style="list-style-type: none"> ● Do not put hands, arms or feet into the backrest's fabrics of traveling sections of the massage wheels. ● Children should not use the product. Keep them from playing on the product or climbing onto the Lower Leg massage section, the seat, the backrest or the armrests. ● Do not climb onto the backrest or the armrests. ● Do not lean or sit on the backrest. ● Persons unable to express themselves clearly or unable to operate the product should not use the product. ● When massing the neck, pay attention to moving directions of the massage wheels and do not massage with a too large force or massage front part of the neck. Otherwise accidents or personal injuries may happen. |
| | <ul style="list-style-type: none"> ● Do not damage the power line or the power plug. (Do not damage, machine, forcedly bend, twist or prolong the power line or the power plug, or place the power line or the power plug close to a heater, or tie or bind any heavy objects on the power line or the power plug.) A damaged power line or power plug may result in electric shocks, short circuit faults or fires. Please consult the shop from which you bought the product or a designated authorized service center about maintenance method of the power line or the power plug. |
| | <ul style="list-style-type: none"> ● Do not insert or pull out the power plug with wet hands. Otherwise electric shocks may happen. |
| | <ul style="list-style-type: none"> ● Do not refit, disassemble or repair the product without permission. Otherwise fires, abnormal movements or personal injuries may happen. |





Important safety instructions

Must be followed

|  Caution | |
|---|--|
|  Must be followed | <ul style="list-style-type: none"> ● The following persons (even if they are physically healthy at present) should consult a physician before using the product. <ol style="list-style-type: none"> (1) Persons with muscular atrophy due to aging or thin persons; (2) Persons feeling lumbago because of bone or viscus problems; (3) Persons tending to suffer sprains or bruising; (4) Persons with carsickness or seasickness or strong response when taking other transport means; (5) Persons who once received a heart operation or another visceral operation; Otherwise health may get worse. ● Before sitting on the product, make sure there is no foreign matter between any two parts of it. (Make sure there is no foreign matter on the backrest, the seat surface, or inside surface of the back cushion.) Otherwise accidents, injuries, or product faults caused by clamping of hands, feet, or other articles by the product may happen. |
| | <ul style="list-style-type: none"> ● Do not use the product when wearing any hard decorative article on head (such as hair pin). ● If there is any hard article (such as mobile phone or key) in a pocket of the trousers, take it out before massage. |
| | <ul style="list-style-type: none"> ● When pulling out the power plug, do not pull the power line but hold the power plug. Otherwise an electric shock or a short circuit fault may happen. |
| | <ul style="list-style-type: none"> ● When moving the product by pulleys, put articles such as mats on the floor. Otherwise marks may be left on the floor. |
| | <ul style="list-style-type: none"> ● Before moving the product by pulleys, remove the obstructions close to it. Otherwise accidents or injuries may happen because of turnover of the product. |
| | <ul style="list-style-type: none"> ● In use, place the product horizontally. Otherwise accidents due to turnover of the product may happen. |
| | <ul style="list-style-type: none"> ● If any symptom such as skin inflammation, itching or swelling in use, stop the product immediately and consult a physician. Otherwise accidents or physical discomfort may happen. |
| | <ul style="list-style-type: none"> ● If the product is used again for massage after a period of out-of-service, read the Operating Instructions again and make sure the product can run normally first. Otherwise accidents or injuries may happen. |
|  Forbidden | <ul style="list-style-type: none"> ● Do not use the product and other devices at the same time. Otherwise accidents or physical discomfort may happen. |
| | <ul style="list-style-type: none"> ● Keep head, abdomen or skin from the massage wheels and do not put hands or feet between the massage wheels. |
| | <ul style="list-style-type: none"> ● Do not fall asleep while using the product. Do not use the product after drinking. ● If air in the filling the air bag on the seat is not completely discharged, do not stand or jump on the seat or put things on it. Otherwise accidents or injuries may happen. |

Important safety instructions

Must be followed

|  Caution | |
|---|---|
|  Forbidden | <ul style="list-style-type: none"> ● Do not put pets on the product (such as its backrest and armrest). ● Do not pull out the power plug or turn OFF the power switch suddenly during massage. Otherwise injuries may happen. |
| | <ul style="list-style-type: none"> ● Do not stand or sit on the armrests. Otherwise personal injuries may happen. |
| | <ul style="list-style-type: none"> ● Do not drag or push the product after it is installed. Otherwise the floor may be damaged. |
|  Wet-hand contact forbidden | <ul style="list-style-type: none"> ● Do not move the product while there is a person on it. Otherwise, accidents, or injuries may happen due to a toppling of the product. |
| | <ul style="list-style-type: none"> ● Do not use the product on heating devices such as electric blankets. Otherwise fires may happen. |
| | <ul style="list-style-type: none"> ● Do not use the product in a bathroom or another wet place. Otherwise electric shocks or product faults may happen. |
|  Product wetting forbidden | <ul style="list-style-type: none"> ● Do not use the product in a bathroom or another wet place. Otherwise electric shocks or product faults may happen. |
| | <ul style="list-style-type: none"> ● Do not sprinkle substances such as water on the product. Otherwise electric shocks, short circuit, or product faults may happen. |
|  Pull out the power plug | <ul style="list-style-type: none"> ● Before cleaning or maintaining the product, pull out the power plug first. Otherwise electric shocks or injuries may happen. |
| | <ul style="list-style-type: none"> ● In the case of a power failure, pull out the power plug at once. Otherwise accidents or injuries may happen when power is restored. |
| | <ul style="list-style-type: none"> ● When the product is not used, pull out the power plug. Otherwise electric leakage fires may happen because of insulation aging caused by dust and moisture. |

Grounding instructions

Grounding instructions

- The product must be grounded to reduce the electric shock hazard because of functional faults of the product.
- The product has a power line with a grounding conductor and a grounding plug. The grounding plug must be inserted into an appropriate socket that has been correctly installed and grounded in full compliance with the local code and decree.

Caution

- If the grounding conductor is not correctly connected, electric shocks may happen. If you are not sure about correctness of the grounding, have it inspected by a professional electrician. Even if the grounding plug provided with the product does not match with the socket you have, do not refit it by yourself but ask a professional electrician to install an appropriate socket.
- The product has a grounding plug. Make sure the product is connected with a socket matching with shape of the grounding plug.
- Do not connect the product to a multi-plug.
- If the power plug is damage, it must be replaced by a special plug available from ITSU or authorize agents.

Product Parts



The legrest can turnover and hide as following:

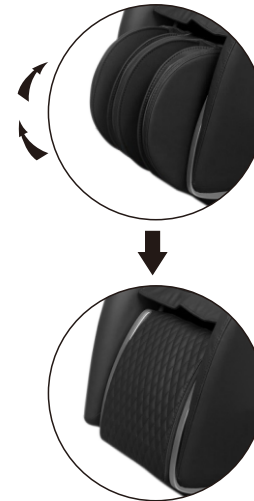

- Total 3 air valves(3 individual massage mechanism)
- A combination of 16 airbags

1 Check the space around the product.

Make sure there is no person, pet or other object close to the product.

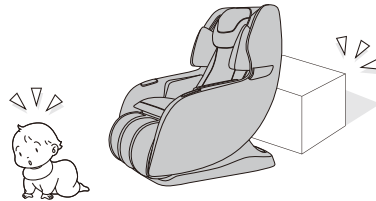

2 Roll up the pillow pad and fix it by the zipper.

Roll up the pillow pad and fix it on the main body by the zipper.

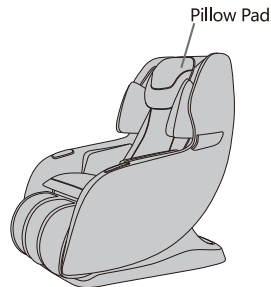

3 Inspect the power line and power plug.

Warning

- Remove such dirt as dust on the power plug at regular intervals. Otherwise fires caused by poor insulation due to factors such as moisture may happen. (Wipe the power plug with dry cloth.)
- Do not damage the power line or the power plug. Do not damage, machine, forcibly bend, twist or lengthen the power line or the power plug, or place the power line or the power plug close to a heater, or tie or bind any heavy objects on the power line or the power plug. A damaged power line or power plug may result in electric shocks, short circuits, or fires. Please consult the shop you bought the product or an authorized service center about maintenance method of the power line or the power plug.

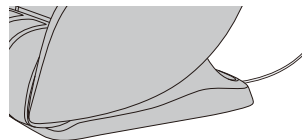

Do not be entangled by the power line.

Push the interface into the power input jack till the end.

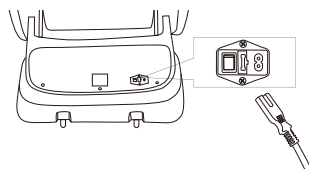

4 Power on the product.

- 1 Insert the power plug into the power socket.
- 2 Pull the power switch to the "I" position.

Warning

- Insert the power plug into the power socket till the end. Otherwise electric shocks or fires because of overheat may happen.
- Abide by the regulations on use of the socket and the wiring devices strictly.
- Use a 220-240V~,50/60Hz power supply. (Do not use the product in a foreign country or connect it with a transformer without permission.) Otherwise electric shocks, product faults or fires because of overeat may happen.
- Do not insert or pull out the power plug with wet hands. Otherwise an electric shock may happen.

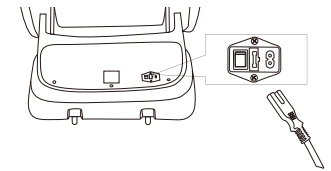

5 Make sure the massage hands are retracted.

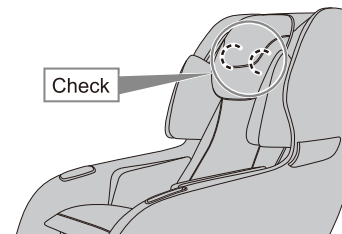

If they are not, press ON return them to the retracting position.

6 Make sure the fabric is not damaged nor cracked.

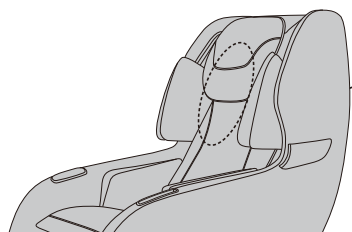

Inspected area:
The fabric of traveling sections of the massage wheels on the backrest

Warning

- Before use, check whether fabrics of the area pointed out in the figure are damaged. (Even if the fabric is slightly damaged, stop the product immediately, pull out the power plug and send the product to repair.) If the product is used when there is fabric damage, you may get injured or get an electric shock.

- ON/OFF**
Press to switch ON the massage chair into standby mode.
Press again to switch OFF.
Default timer is 15 minutes.
- AUTO PROGRAM**
Press to select auto program as below:
Auto1—Auto2—Auto3—Auto4—Auto5—Auto6—Auto7
- AIR MESSAGE SELECTION**
Press to select air massage as below:
All—Leg—Seat—Shoulder—OFF
- MANUAL MODE**
Press to select manual massage mode as below:
Kneading1—Kneading2—Tapping—Kneading&Tapping—Shiatsu1—Shiatsu2—Rolling—OFF
- MESSAGE INTENSITY**
Press to adjust massage intensity as below, 6 adjustable levels, default intensity level 2:
Level 1—Level 2—Level 3—Level 4—Level 5—Level 6
*** Long press for 2 seconds to enable/disable HEAT function.**
- FULL BODY** (preset for manual massage)
- UPPER BODY** (for manual massage)
*** Long Press for 2 seconds to move massage roller upward.**
- SPOT** (for manual massage)
- LOWER BODY** (for manual massage)
*** Long press for 2 seconds to move massage roller downward.**
- SWING**
Press to enable SWING function, massage chair will begin to swing at preset interval.
*** Long press for 2 seconds to adjust massage width during MANUAL mode.**
- ZERO GRAVITY**
Press to go Zero gravity position.
Press again to stop.
*** Long press for 2 seconds to adjust backrest to upright position.**

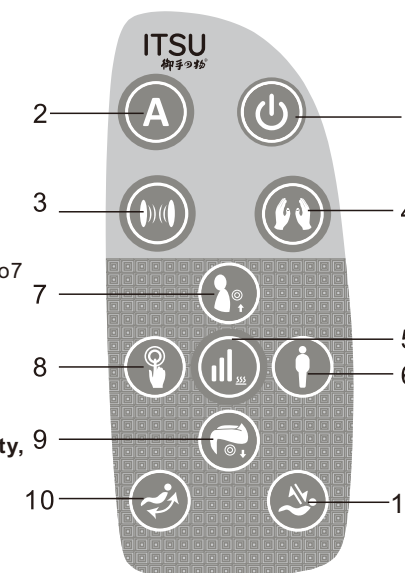

AUTO

- 1: Sweet Home
- 2: Lady
- 3: Office
- 4: Arch Neck
- 5: Sport
- 6: Shopping
- 7: Sweet Dream

Operation Instruction

APP Installation

1. Compatible with the following mobile oses:



IOS 13



Android 10



Bluetooth 4.0

2. Turn on your mobile phone's bluetooth and WIFI or 3G/4G.

3. Scan the QR below to install ITSU WORLD app.



Android



IOS

Operation Instruction

Interface of APP and descriptions

1. Switch ON the APP, HOME screen page will be displayed. Please choose your desire features. An extra auxillary HOME screen is also available with comprehensive features.



2. Body Analyzing

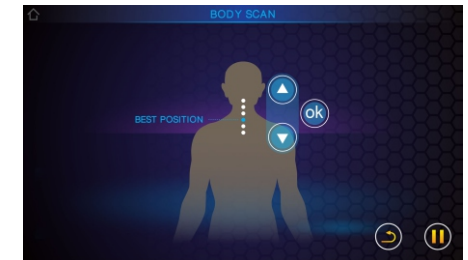
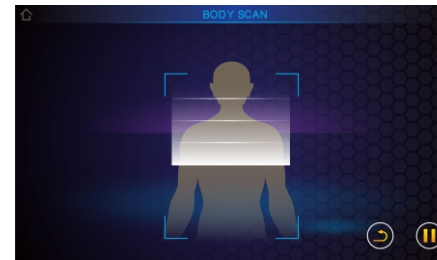

- Massage chair will start with Smart Scan Body Sensing technology to detect body condition.
- After Smart Scan, in 8 seconds, users are given an option to fine tune 'shoulder position ' based on user needs.

3. AUTO



- There are 7 specially designed automatic programs as described above.

Operation Instruction

4. MANUAL MODE



- App has 9 massage modes: Kneading 1, Kneading 2, Tapping 1, Tapping 2, Kneading&Tapping 1, Kneading&Tapping 2, Shiatsu 1, Shiatsu 2 and Rolling.
- Remote control has 7 massage modes: Kneading 1, Kneading 2, Tapping, Kneading&Tapping, Shiatsu 1, Shiatsu 2 and Rolling.
- 6 levels of Massage Speed/Strength setting.

5. AIRBAG



- 3 airbag massage coverage(PART): shoulder,seat,legrest

6. SETTING



- 4 languages are available to choose: Chinese,English,Japanese and Malay.
- Mute button
- Bluetooth: ON/OFF
- Timer setting: 5,10,15 and 20 minutes

Operation Instruction

Key introduction of APP

Interface 1:

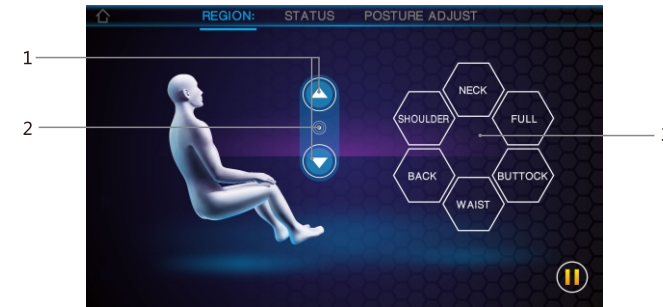

1. Gear box roller upward/downward adjust
2. Spot massage function
3. Massage area selection (for manual massage only).

Interface 2:

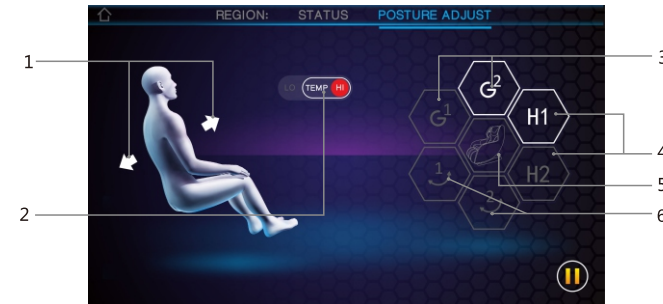

1. Backrest incline/decline
2. Temperature adjust
3. Zero G position selection
4. Hi/Lo temperature selection
5. Upright position
6. Swing mode selection

Operation Instruction

Interface 3:

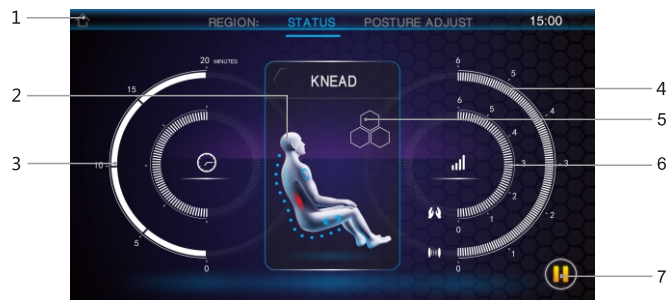

1. Home button
2. Massage Indication
3. Timer setting: 5,10,15 and 20 minutes
(Change the automatic program, the time restarts to count down; change the manual program and air pressure, the time does not change.)
4. Airbag intensity:6 adjustable levels
5. Massage program shortcut button
6. Massage strength:6 adjustable levels
7. PLAY/PAUSE button

After massage

Power off the product.

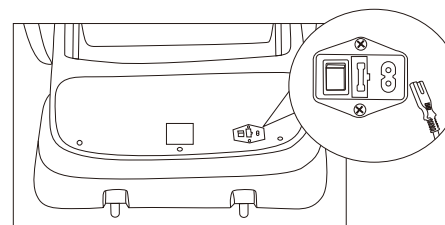

- ① Turn off the power switch.
- ② Pull out the power plug.

Warning

- After use each time, pull the power switch to the **O** position and pull out the power plug; otherwise accidents and injuries by playing with them by children may happen.

Timer function

Message will end automatically when 15 minutes timer is end.

Cleaning and maintenance

Cleaning of the synthetic leather

Wipe the synthetic leather with a soft dry cloth.

- **Do not clean the product with chemicals such as thinners, gasoline and alcohol.**
- **When using a leather maintenance product (cleaning cloth) sold on the market, follow its directions for use.**
- **If the synthetic leather is very dirty, wipe it with the method below.**
 - ① Put a piece of soft cloth into water or 3% to 5% neutral detergent contained hot water and wring it out.
 - ② Wipe surface of the synthetic leather with the soft cloth.
 - ③ Wipe the detergent with a piece of cloth once soaked in clean water and wrung out.
 - ④ Wipe with a piece of wrung soft cloth.
 - ⑤ Have the synthetic leather take natural air drying.
- **If it is difficult to remove the stains on the synthetic leather, soak a piece of melamine foam bought from the market into a neutral detergent and use it wipe the product.**
- **Do not dry the surface by a hair drier.**
- **Surface of the synthetic leather may be dyed by fabric colors; therefore, be careful when wiping the product with denim or colored cloth.**
- **Keep these positions from long-time contact with plastics to avoid fading.**
- **Synthetic leather may discolor, so the position in contact with the hair dye used should be covered by a towel.**

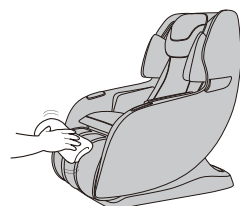

Cleaning of the plastic parts

1 Put a piece of soft cloth into water or neutral detergent contained hot water, wring it out and wipe the plastic parts.

- Do not clean the product with chemicals such as thinners, gasoline and alcohol.

2 Wipe with a piece of cloth once soaked in clean water and wrung out.

- Wring the cloth out before using it to wipe the remote controller.

3 Have the plastic parts take natural air drying.



Questions and answers (Q&A)

Q Can persons paying frequent visits to hospitals because of diseases use the product?

A These persons should consult physicians before using the product. Massage is the so-called "touch-pressure stimulation": Muscles are compressed to relieve their tension and promote hemokinesis. Some diseases may get worsened because of massage. Thus, consult the attending doctors before using the product.

Q Are there any things needing special attention during moving?

A Pay attention to the following things during moving.

- Turn off the power switch and pull out the power plug.
- If the original packing box is unavailable, make sure the power line is not wound on the product, wind it and place it on the seat surface. When handling the product, keep the power line from falling off and rubbing with ground.
- If the original packing box is unavailable, properly keep other packing auxiliary materials and wrap the product with them to avoid scratch and vibration during handling.

Q I care about the sounds the product makes when being used.

A It is caused by the core structure.

Q Does it matter if the massage wheels have different massage intensities?

A This phenomenon possibly exists during massage because of the core structure. To simulate the most natural massage effect, the product is designed with a core structure allowing alternate back massage by a left massage wheel and a right massage wheel. During massage, the massage wheels possibly have slightly different positions on the back. That's why you have that feeling. It is not a fault.

Q How about monthly power consumption of the product?

A Supposing you massage for 30 minutes in two times (15 minutes for each time) on each day, about 0.87 kilowatt-hours will be consumed each month.

Troubleshooting

Troubleshooting (Continued)

After a fault happens, inspect and try the corresponding method below.

If the fault still exists after that, contact the shop from which you bought the product.

| Fault | Cause and elimination method |
|--|--|
| The massage wheels stop during use | <p>For safety, the massage wheels will possibly stop upon a too large external force during use.</p> <p>If the massage wheels stop again, adjust your sitting posture and do not lean on the backrest completely. (Users, particularly those heavier than 100 kilograms, should follow relevant precautions.)</p> |
| The left and right massage wheels have different heights (intensities) | It is not a fault but a normal phenomenon because the product is provided with a massage core allowing alternate beats of the massage wheels. |
| The product cannot run at all. | <ul style="list-style-type: none"> ● The power line is disconnected. ● The power switch is not turned on. ● No program is selected after ON button on the controller is pressed. |
| The product is damaged. | To avoid accidents, contact an authorized service center. |
| The power line or the power plug has abnormal heating. | |

If above solution are not applicable, kindly contact ITSU service Center.

The sounds and feelings you care about in use of the product

You will hear or have the following sounds or feelings when using the product. It is not abnormal phenomena but results of the product structure.

- Sound and feeling when the massage wheels rub patterns on the fabric
- Sound of movements such as kneading and beat
- Friction sound of the running massage wheels
- Sound of up-down movement
- Sound of the conveyor belt
- Motor sound
- Sound when a person is sitting on the seat
- Friction sound between the armrests and the back cushion when the backrest is tilting
- Friction sound between the massage wheels and the fabric
- Sound of the inflator pump during Air Bag massage
- Sound of air exhaust during Air Bag massage
- Running sound of the solenoid valve at bottom of the product during Air Bag massage.
- Swing of the footrest
- Sound when the shoulders are stretched or moved
- Running sound of the air bags
- Friction sound between the back cushion and the back cover leather when the backrest is tilting

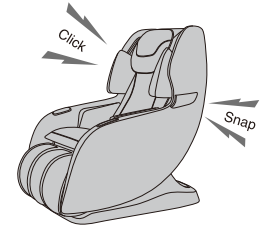

If the sound is loud, it is also possible that the product has failed.

- In this case, have the product inspected and repaired by an authorized service center.

Warning

- Do not refit, disassemble or repair the product without permission. Otherwise fires, abnormal movements or personal injuries may happen.

Warning

- In the case of any abnormality or fault, stop the product immediately and pull out the power plug to avoid fuming, fires and electric shocks.
- < Abnormality and fault examples >
- The product fails to work after the power switch is turned to the ON position;
 - After the power line is moved, the product is discontinuously powered on;
 - In use, the product gives off a burning smell or an abnormal sound;
 - The product is deformed or abnormally heating
- In any of these abnormalities and faults, have the product inspected and repaired by an authorized service center immediately.

Specifications

| | |
|--|------------------------------|
| Power supply | 220-240V~, 50/60Hz |
| Power consumption | 65W |
| Dimensions When it is not tilting: (LXWXH) | Approx. 107.5cmx66cmx109cm |
| Weight | Approx. 56kg |
| Dimensions of packing box (LXWXH) | Approx. : 116cmx73.5cmx116cm |
| Weight (including the packing box) | Approx:65kg |
| Maximum body weight of user | 90kg |

For a user heavier than 90 kilograms, the product may have bigger noise and its fabric housing may be worn out quicker.

Specifications

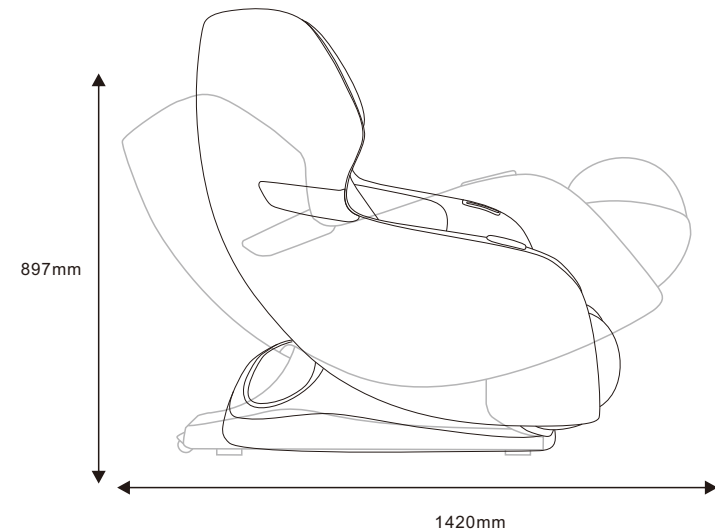
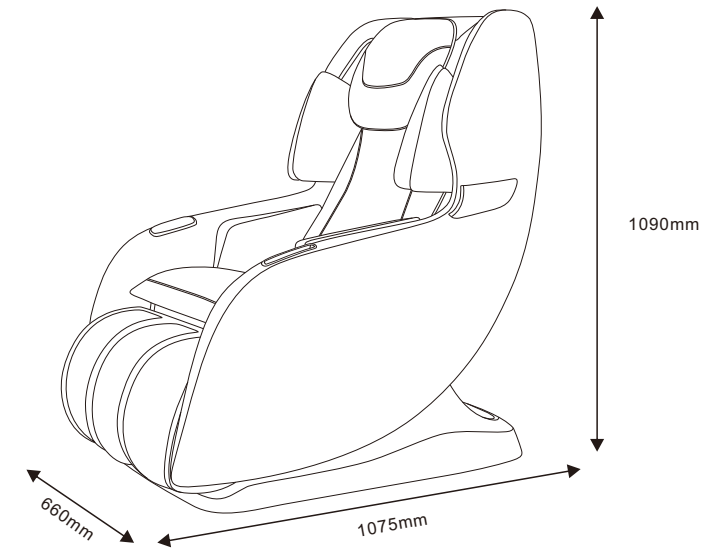

Contact Us



ITSU World Sdn Bhd
13 Lorong Teknologi B. Nouvelle Industry Park.
Taman Sains SG1 Kota Damansara. PJU 5.
47810 Petaling Jaya
Malaysia
Tel: +603 6732 3722



ITSU World(HK) Limited
Workshop D1,28/F. TML Tower
No. 3 Hoi Shing Road, Tsuen Wan, N.T.
Tel: +852 3611 2228



PT Healthy World
Lodan Center Block O No 20
Jalan Lodan Raya No 2
Jakarta Utara 14430
Tel: +62 21-6983 1123

ITSU
御手の物®

產品說明書

IS6028

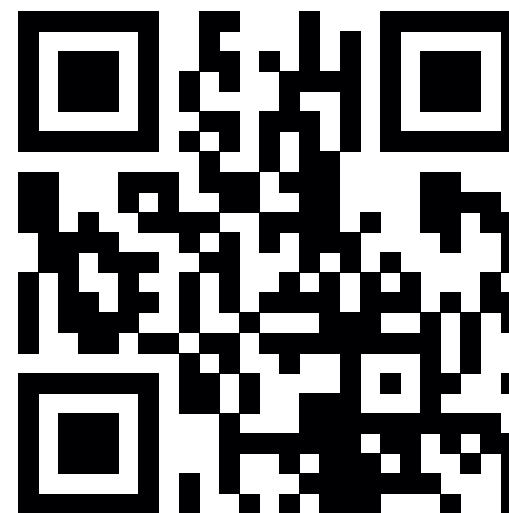

請掃描我
多謝支持環保

目錄

使用前

- 重要的安全事項 SC1
- 接地說明 SC5
- 產品結構 SC6
- 使用前 SC7

使用方法

- 操作說明 SC10
- 按摩結束 SC16

維護

- 清洗及保養 SC17

Q&A/重要事項



- Q&A SC18
- 故障檢修 SC19
- 規格 SC21
- 聯絡我們 SC23

重要的安全事項

必須遵守



下文列舉的是使用中為防止人身、財產損害而必須嚴格遵守的安全事項。

■ 所有安全事項將根據因錯誤使用而導致危害或損害的程度，予以說明。





| | |
|---|-------------------|
|  警告 | 可能造成重傷或死亡後果的事項內容。 |
|  注意 | 可能造成輕傷或財產損害的事項內容。 |

■ 請注意各安全事項前的符號。（下文為符號範例）





| | |
|--|--|
|  絕對禁止事項。 |  必須執行事項。 |
|--|--|

|  警告 | | | |
|--|---|--|---|
| | <p>● 正在接受治療或有以下列症狀的人，在使用本機前，應諮詢醫師。</p> <table style="width: 100%; border: none;"> <tr> <td style="width: 50%; border: none;"> (1) 佩戴起搏器或其他易受電子干擾的體內植入型電子醫療器械的人 (2) 惡性腫瘤病人 (3) 心臟病人 (4) 被查證喪失辨別溫度能力的人 (5) 孕婦或剛完成分娩的人 (6) 因糖尿病等高度末梢迴圈障礙引起知覺障礙的人 (7) 骨質疏鬆症患者、脊柱骨折病人、患有扭傷或肌肉拉傷等急性疼痛性疾病的人 </td> <td style="width: 50%; border: none;"> (8) 按摩部位受傷的人 (9) 體溫在38°C以上（有發熱症狀）的人 (10) 必須靜養或身體顯著不適的人 (11) 脊柱異常或脊柱彎曲的人 (12) 患有椎間盤突出的人 (13) 除上述之外，身體感覺特別不適的人 </td> </tr> </table> <p>否則恐發事故或造成身體不適。</p> | (1) 佩戴起搏器或其他易受電子干擾的體內植入型電子醫療器械的人 (2) 惡性腫瘤病人 (3) 心臟病人 (4) 被查證喪失辨別溫度能力的人 (5) 孕婦或剛完成分娩的人 (6) 因糖尿病等高度末梢迴圈障礙引起知覺障礙的人 (7) 骨質疏鬆症患者、脊柱骨折病人、患有扭傷或肌肉拉傷等急性疼痛性疾病的人 | (8) 按摩部位受傷的人 (9) 體溫在38°C以上（有發熱症狀）的人 (10) 必須靜養或身體顯著不適的人 (11) 脊柱異常或脊柱彎曲的人 (12) 患有椎間盤突出的人 (13) 除上述之外，身體感覺特別不適的人 |
| (1) 佩戴起搏器或其他易受電子干擾的體內植入型電子醫療器械的人 (2) 惡性腫瘤病人 (3) 心臟病人 (4) 被查證喪失辨別溫度能力的人 (5) 孕婦或剛完成分娩的人 (6) 因糖尿病等高度末梢迴圈障礙引起知覺障礙的人 (7) 骨質疏鬆症患者、脊柱骨折病人、患有扭傷或肌肉拉傷等急性疼痛性疾病的人 | (8) 按摩部位受傷的人 (9) 體溫在38°C以上（有發熱症狀）的人 (10) 必須靜養或身體顯著不適的人 (11) 脊柱異常或脊柱彎曲的人 (12) 患有椎間盤突出的人 (13) 除上述之外，身體感覺特別不適的人 | | |
| | <p>● 使用中感到身體異常、或使用後覺得沒有效果時，請立即停止使用，並諮詢醫師。</p> <p>否則恐發事故或造成身體不適。</p> | | |
|  必須遵守 | <p>● 每次按摩請控制在30分鐘內。</p> <p>● 請將對身體同一部位的按摩控制在5分鐘內。</p> <p>否則可能出現負面效果並造成傷害。</p> | | |
| | <p>● 每次使用完畢，應將電源開關滑到“O”（關閉）位置，拔掉電源插頭。</p> <p>否則可能因兒童頑皮引發事故或造成傷害。</p> | | |
| | <p>● 請嚴格遵守插座和配線器具的使用規定。</p> <p>● 請使用220-240V~，50/60Hz交流電。</p> <p>（請勿在國外使用本品，或擅自連接變壓器。）</p> <p>否則可能引發觸電、機體故障或因過熱導致火災。</p> | | |
| | <p>● 請務必將電源插頭插到底，使其確實地插入插座中。</p> <p>否則可能引發觸電或因過熱導致火災。</p> | | |

重要的安全事項 必須遵守





|  警告 | |
|---|---|
|  必須遵守 | <ul style="list-style-type: none"> ● 請定期清理電源插頭上的灰塵等髒污。否則可能因溫氣等原因引發絕緣不良，從而導致火災。（請用乾燥的抹布擦拭電源插頭。） ● 發生異常、故障時，立即停止使用，拔掉電源插頭。（否則可能冒煙、起火、觸電）（異常、故障事例）。 <ul style="list-style-type: none"> ● 接通電源開關後可能不動作。 ● 移動電源線，有時通電有時不通電。 ● 運行中發出焦臭味、異常聲響。 ● 按摩椅變形或者異常發熱。 → 請立即委託授權服務中心檢查和修理。 |
|  禁止 | <ul style="list-style-type: none"> ● 請握住邊框進行本機搬送。否則可能會導致機體故障或人身傷害。 |
| | <ul style="list-style-type: none"> ● 下列人員請勿使用本機。 被醫生禁止按摩的人（例：患有血栓症、重度動脈瘤、急性靜脈瘤、各種皮膚炎或皮膚感染症（包括患皮下組織炎症）的人等） 否則可能會導致病情惡化。 |
| | <ul style="list-style-type: none"> ● 下列人員請勿使用腰部按摩。 <ul style="list-style-type: none"> ● 患有急性腰痛、椎間盤突出症、腰椎移位症的人 ● 罹患變形性關節炎等關節不適的人 否則可能會導致病情惡化。 |
| | <ul style="list-style-type: none"> ● 在使用中請勿將手、手臂、腳塞入靠背覆蓋在按摩輪活動範圍上的面料。 ● 兒童禁止使用本機。此外，請勿讓兒童在本機上玩耍，或者爬到小腿按摩部、座面、靠背或扶手上。 ● 請勿攀爬靠背或者扶手。 ● 請勿倚背或坐在靠背上。 ● 請勿讓不能表達自己意思的人或沒有能力操作本機的使用本機。 ● 按摩頸部時，請注意按摩輪的動向，請勿按摩前頸，請避免過重地按摩頸部。否則可能會引起事故或造成傷害。 |
|  濕手禁止 | <ul style="list-style-type: none"> ● 請勿損壞電源線及電源插頭 （請避免此類行為：損傷、加工、強行彎曲、扭轉、拉長源線及電源插頭，或將電源線及電源插頭靠近發熱器，或在電源線及電源插頭上系重物、或任意捆綁。） 使用破損的電源線或電源插頭，可能引起觸電、短路或引發火災，請到購買本品的商店或指定的維修中心諮詢修理電源線或電源插頭的方法。 |
| | <ul style="list-style-type: none"> ● 請勿用沾濕的手插、拔電源插頭。否則可能導致觸電事故。 |
| | <ul style="list-style-type: none"> ● 請勿擅自改造本機。請勿自行分解或修理本機。否則可能導致起火、異常動作、人身傷害。 |

重要的安全事項 必須遵守

|  注意 | |
|---|--|
|  必須遵守 | <ul style="list-style-type: none"> ● 下列人員即使目前身體健康，也請諮詢醫師後再使用本機。 (1) 因年齡增長而導致肌肉萎縮的人或身體纖瘦的人 (2) 因骨頭或內臟問題而感覺腰痛的人 (3) 容易扭傷或容易瘀傷的人 (4) 暈車、暈船或乘坐其他交通工具時，反應異常激烈的人 (5) 過去曾被施予心臟手術或其它內臟手術的人 否則可能有損自身健康。 |
| | <ul style="list-style-type: none"> ● 就坐前，請先確認本機各個部件之間沒有異物。（確認靠背、座面、靠墊內側沒有夾雜異物。） 否則可能因手、腳或其他物件被本機夾住，而引發事故、造成傷害或機體故障。 |
| | <ul style="list-style-type: none"> ● 頭部佩戴任何硬質飾物（如髮卡等）時請勿使用本機。 ● 當褲子口袋內部有硬物時（如手機、鑰匙等），將其取出，然後按摩。 |
| | <ul style="list-style-type: none"> ● 就座前，確認按摩輪處在收納位置。 ● 按摩途中若想離開座位，必須先停止按摩椅運作，再離開座位。否則可能引發事故或造成傷害。 |
|  禁止 | <ul style="list-style-type: none"> ● 請勿扯電源線試圖拔出電源插頭，一定要握住插頭本身將其拔出。否則可能引發觸電或短路。 |
| | <ul style="list-style-type: none"> ● 移動本機前，必須把小腿按摩部的角度調節回最初位置。否則可能造成傷害。 |
| | <ul style="list-style-type: none"> ● 如果使用滑輪滾動本機，在地板上墊上墊子等。否則可能在地板上留下傷痕。 |
| | <ul style="list-style-type: none"> ● 使用滑輪移動本機前，須先清空周圍障礙物，慢慢移動。否則可能因機身翻倒引發事故或造成傷害。 |
| | <ul style="list-style-type: none"> ● 須將本機放置在水平面上使用。否則可能因機身翻倒引發事故。 |
| | <ul style="list-style-type: none"> ● 因使用本產品而產生出疹、紅腫、發癢等症狀時，請立即停止使用，並諮詢醫師。否則可能引發事故或導致身體不適。 |
|  禁止 | <ul style="list-style-type: none"> ● 閒置一段時間後使用本品，請先重新閱讀一遍產品使用說明書，並確認機體運作正常後，再開始使用。否則可能引發事故或造成傷害。 |
| | <ul style="list-style-type: none"> ● 請勿和其他器械同時使用。否則可能造成事故或引起身體不適。 |
| | <ul style="list-style-type: none"> ● 請勿將頭部、腹部或皮膚緊貼按摩輪。此外，請勿將手或腳伸入按摩輪之間。 ● 勿在使用本機時入睡。此外，飲酒後請勿使用本機。 ● 當鼓起的座面氣囊裡的空氣沒有被排放完時，不要站在座面上，或者跳上去，或者在上面放東西。否則可能導致事故、傷害。 |

重要的安全事項 必須遵守

接地說明

|  注意 | |
|---|---|
|  禁止 | <ul style="list-style-type: none"> ● 請勿將手、手臂或頭伸入小腿按摩部（腳置台）的縫隙間。 ● 請勿將手、手臂或頭伸入靠背和後蓋之間。 ● 請勿將寵物放在按摩椅上（後蓋、靠背、扶手等）。 ● 按摩中，請勿突然拔出電源插頭、或突然關閉電源開關。 否則可能造成傷害。 |
| | <ul style="list-style-type: none"> ● 請勿站立或坐在後蓋上。 否則可能導致本機翻倒，造成人身傷害。 |
| | <ul style="list-style-type: none"> ● 請勿站立或坐在扶手上。 否則可能導致人幣傷害。 |
| | <ul style="list-style-type: none"> ● 請勿站立或坐在小腿按摩部及腳置臺上。 否則腳置台前部旋轉或本機傾倒可能導致事故、傷害。 |
| | <ul style="list-style-type: none"> ● 請勿在已安裝好的狀態下托動或推動本機。 否則可能損壞地板。 |
| | <ul style="list-style-type: none"> ● 請勿在有人入座時移動本機。 否則可能因機身翻倒引發事故或造成傷害。 |
| | <ul style="list-style-type: none"> ● 請勿在電熱毯等加熱設備上使用本機。 否則可能引起火災。 |
|  禁止濕手觸碰 | <ul style="list-style-type: none"> ● 請勿在浴室或其他潮濕的地方使用本機。 否則可能引發觸電或機體故障。 |
|  禁止沾濕 | <ul style="list-style-type: none"> ● 請勿將水滴等物質撒在本機上。 否則可能引發觸電、短路或引起機體故障。 |
|  拔出電源插頭 | <ul style="list-style-type: none"> ● 清洗及保養本機，必須先從插座上拔出電源插頭。 否則可能引發觸電或造成傷害。 |
| | <ul style="list-style-type: none"> ● 停電時立刻拔出電源插頭。 否則可能在恢復供電時導致事故、傷害。 |
| | <ul style="list-style-type: none"> ● 不用時，一定要從插座上拔出電源插頭。 否則灰塵、濕氣可能導致絕緣老化，引發漏電火災。 |

接地說明

- 本機必須接地。如果本機發生功能故障，可以使用接地來減少觸電危險。
- 本機裝備了具有設備接地導線和接地插頭的電源線。必須將該插頭插入已完全依照當地代碼和法令進行正確安裝和接地的、合適的插座。

注意

- 若設備接地導線的連接不當，則會導致觸電危險。如果您對本機的接地是否正確存有疑問，請委託專業電工進行檢查。即使本機附帶的插頭與插座不配，也不能對其進行改造。請委託專業電工安裝合適的插座。
- 本機具有接地插頭。請確認本機連接至具有與插頭形狀匹配的插座。
- 本機不能使用轉接插座。
- 如果電源線損壞，必須使用專用的電源線或從其製造商或維修部買專用元件來更換。

產品結構



如下圖所示，腿部可向上翻轉：

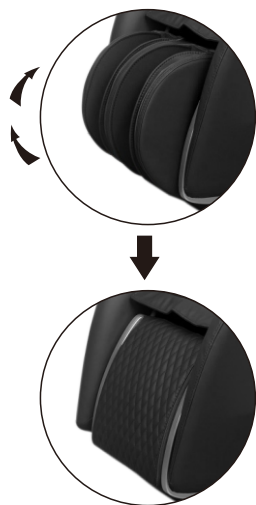

- 一共3個氣閥（3個獨特的按摩機制）。
- 16個氣囊組合。

SC 6

使用前

1 檢查周圍

確定本機周圍沒有人、
寵物及其他物體。

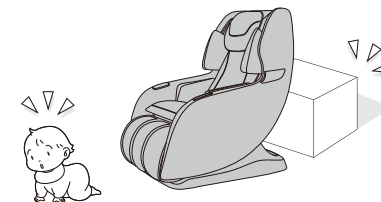

2 卷起枕頭並以拉鍊固定

卷起枕頭並以拉鍊固定在本體上。

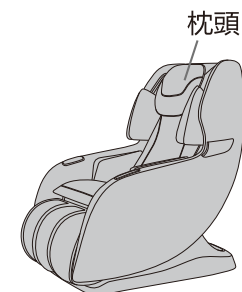

3 檢查電源線及電源插頭

警告

- 請定期清理電源插頭上的灰塵等髒污。
否則可能因濕氣等原因引發絕緣不良，從而導致引發火災。
（請用乾燥的抹布擦試電源插頭。）
- 請勿損壞電源線及電源插頭。
（請避免此類行為：損傷、加工、強行彎曲、扭轉、拉長電源線及電源插頭，或將電源線及電源插頭靠近發熱器，或在電源線及電源插頭上系重物、或任意捆綁。）
使用破損的電源線或電源插頭，可能引起觸電、短路或引發火災。請到購買本機的商店或指定的維修中心諮詢修理電源線或電源插頭的方法。

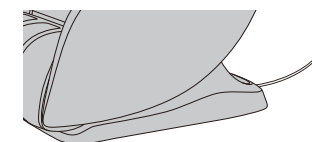

請注意，
不要被電源線絆住腳部等。

務必將接口完全推入設備
電源輸入插口。

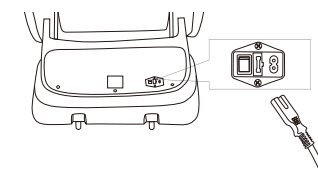

SC 7

4 打開電源

- 1 將電源插頭插入電源插座。
- 2 將電源開關滑到“1”（開啟）的位置。

|  警告 |
|--|
| ● 請務必將電源插頭插到底，使其確實地插入插座中。 否則可能引發觸電或因過熱導致火災。 |
| ● 請嚴格遵守插座和配線器具的使用規定。 ● 請使用220-240V~50/60Hz交流電。 (請勿在國外使用本品、或擅自連接變壓器。) 否則可能引起觸電、機體故障或因過熱導致火災。 |
| ● 請勿用沾濕的手插、拔電源插頭。 |

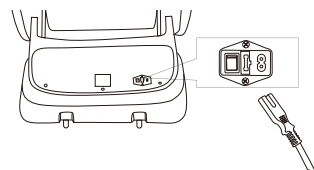

5 確認按摩輪處於收納位置

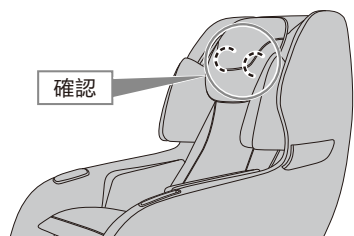

按摩輪不處於收納位置時，
按下開機鍵返回收納位置。

6 確認面料未破損或存在裂縫

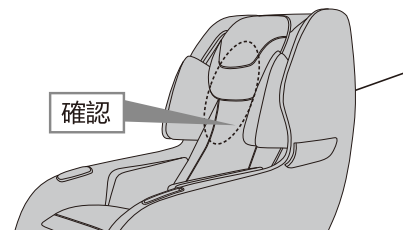

檢查區域：
靠背覆蓋在按摩輪活動範圍上的面料

|  警告 |
|--|
| ● 在使用本機前，檢查圖示區域面料是否破損，其他部分也要確認面料是否破損。 (無論發現多麼細小的破損，都請立刻停止使用， 拔掉電源插頭，並將本機送修。) 在面料破損情況下使用本機，可能引發傷害或觸電的危險。 |

操作說明

操作說明

控制器按鍵功能說明：

1. 整機功能開關鍵。

第一次按開機，再按一次關機，只有在開機狀態下其他按鍵才有效。開機後默認定時時間為15分鐘，開機自動倒到一定角度。

2. 自動功能選擇鍵。切換順序如下

自動1-自動2-自動3-自動4-自動5-自動6-自動7

3. 氣壓按摩功能鍵。切換順序如下

肩部+座部+腿部 - 腿部 - 座部 - 肩部 - 開關

注：座部充氣時，兩邊側板會往外膨脹，這屬於正常現象，請勿擔心。

4. 手動功能按摩鍵。切換順序如下

揉捏1 - 揉捏2 - 敲擊 - 揉敲 - 指壓1 - 指壓2 - 推拿 - 關

***手動開啟時默認為全身。**

5. 強度調節和加熱開關鍵。點按時為強度調節鍵，六檔可調，開機默認為2檔。切換順序如下

1檔 - 2檔 - 3檔 - 4檔 - 5檔 - 6檔

***長按時為加熱開關鍵，可開啟或關閉按摩椅的加熱功能。**

6. 全身區域按摩開關鍵。

7. 上半身區域按摩開關鍵。*長按時機芯往上移。

8. 定點按摩功能開關鍵。

9. 下半身區域按摩開關鍵。*長按時機芯往下移。

10. 搖搖椅功能開關鍵。*長按2秒調整手動按摩時，輪子的寬中窄位

11. 零重力功能開關鍵。點按靠背往後倒，長按靠背起來。

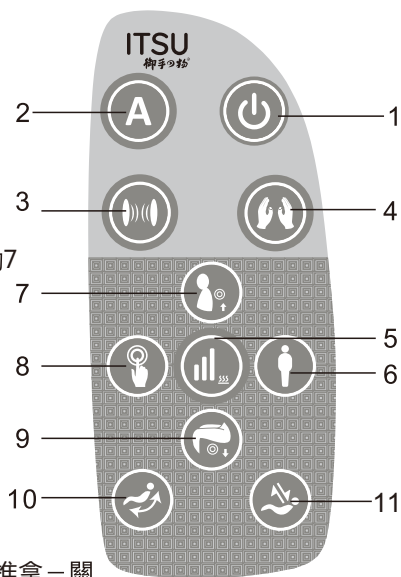

自動程序

自動1：居家族
自動2：愛美族
自動3：上班族
自動4：低頭族
自動5：運動族
自動6：購物族
自動7：織夢族

APP安裝：

1. 適用於以下智能系統。



IOS 13



Android 10



Bluetooth 4.0

2. 開啟藍牙

3. 手機連接網路（建議WiFi或4G），掃描下麵二維碼，下載安裝 ITSU WORLD 的APP。



Android



IOS

APP界面和描述

1. 打開APP，將顯示主頁菜單，請選擇您想要的功能，或者點擊螢幕下方頁面切換按鈕，進入另一綜合功能界面。



2. 檢測

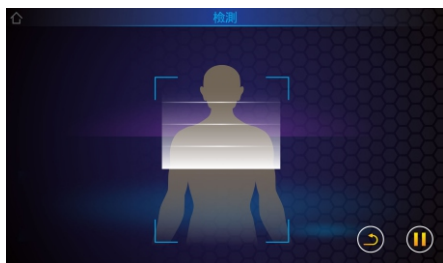

- 按摩椅將開啟使用智能掃描感應技術來檢測身體狀況。
- 智能掃描之後，在8秒鐘內，用戶可以根據需求選擇微調肩部的的位置。

3. 自動程序



- 設有7種自動按摩程序。

4. 手動按摩模式



- APP設有9種按摩模式：揉捏1、揉捏2、敲擊1、敲擊2、揉敲1、揉敲2、指壓1、指壓2、推拿。
- 手控器設有7種按摩模式：揉捏1、揉捏2、敲擊、揉敲、指壓1、指壓2、推拿。
- 6檔按摩速度/力度可設置。

5. 氣壓



- 設有3個氣壓位置：肩部、座部、腿部。

6. 設置



- 4種語言可供選擇：繁體中文、英文、日文及馬來文。
- 靜音按鍵；
- 藍牙功能開啟/關閉；
- 時間設置：5、10、15以及20分鐘；

操作說明

APP界面按鍵介紹：

界面一：



1. 機芯上行/下行調節鍵
2. 定點按摩
3. 按摩區域選擇鍵（僅手動模式）

界面二：



1. 椅背升降調節鍵
2. 溫度調節鍵
3. 零重力功能選擇鍵
4. 溫度選擇鍵
5. 坐姿復位鍵
6. 搖擺功能選擇鍵

操作說明

界面三：

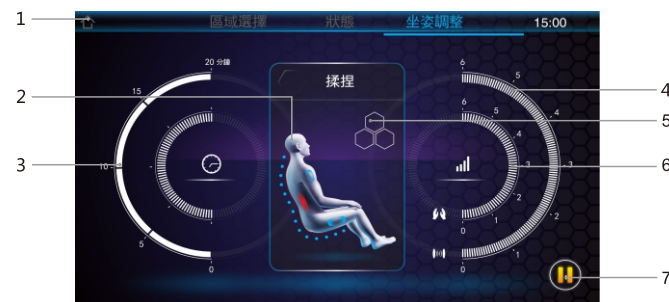

1. 主頁返回鍵及顯示
2. 按摩狀態顯示
3. 按摩時間調整鍵及顯示，可選擇5、10、15以及20分鐘
(變更自動程序，時間重新開始倒計時；變更手動程式及氣壓，時間不變。)
4. 氣壓力度調整鍵及顯示，有6檔力度可選擇
5. 按摩程序快捷鍵
6. 按摩力度調整鍵及顯示，有6檔強度可選擇
7. 運行/暫停鍵

按摩結束

切斷電源

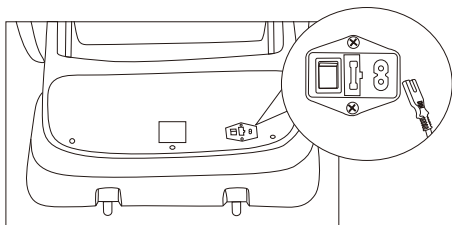

- ① “關閉” 電源開關
- ② 拔下電源插頭

警告

- 每次使用完畢，應將電源開關滑到“0”（關閉）位置，拔掉電源插頭。

否則可能因兒童頑皮引發事故或造成傷害。

關於定時器功能

按摩開始後啟動定時功能，定時時間到後將自動結束。

清洗及保養

清潔合成皮革部分

使用柔軟的幹布擦拭皮革。

- 切勿使用諸如稀釋劑、汽油、酒精等化學品清潔本機。
- 使用市面銷售的皮革保養品（抹布）時，請遵照其使用說明。
- 如果合成皮革特別髒，則通過以下方式擦拭。
 - ① 將軟布浸入水中或含3%至5%中性洗滌劑的熱水中，然後徹底擰乾
 - ② 使用上述軟布擦拭皮革表面。
 - ③ 使用浸過清水且已徹底擰乾的布料擦掉清潔液。
 - ④ 使用擰乾的軟布擦拭。
 - ⑤ 使其自然風乾。
- 難以去除污漬時，請將市面上購買的三聚氰胺泡棉浸入中性洗劑中，然後且它擦拭本機。
- 不要使用吹風機吹幹表面。
- 由於布料的顏色會染到合成皮革的表面上，因此在使用牛仔布和彩色布料擦拭本機時務必小心。
- 不要使這些部位長時間與塑膠接觸，因為這會導致褪色。
- 合成皮革有變色的可能，所以在使用染髮劑時，請將接觸的部分用毛巾覆蓋。

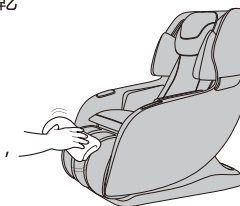

1 將軟布浸入水中或含有中性洗滌劑的熱水中，擰乾後，擦拭本機塑膠部。

- 切勿使用諸如稀釋劑、汽油、酒精等化學品清潔本機。

2 使用浸有清水且已徹底擰乾的布料擦拭。

- 擦拭遙控器前請務必擰乾布料。

3 使其自然風乾。



Q 因為生病而經常出入醫院的人可以使用本品嗎？

A 經常出入醫院的人，請在與醫生商量的前提下使用本品。

按摩即所謂“觸壓刺激”，即通過對肌肉進行壓迫，緩解肌肉緊張，促進血液流動。根據不同的病因，按摩有可能造成病情惡化，因此請務必在和主治醫生商量之後使用本品。

Q 搬家時，有什麼需要特別注意的地方？

A 請注意以下事項。

關閉電源開關，拔出電源插頭。

- 在有原紙箱的情況下，請先確認電源線未被纏繞在本機上，將電源線纏好放在座面上，搬運的時間請注意電源線沒有掉落且未與地面發生摩擦。
- 在沒有原裝紙箱的情況下，為了防止機體劃傷和搬運中的震動，請妥善使用其它包裝輔材包裹本品。

Q 有點在意按摩椅運作時發出的聲音……

A 按摩椅運作時產生的聲音，一般是由於機芯構造而發出的。

Q 按摩中感覺左右兩邊按摩輪的按摩力度有差異，要緊嗎？

A 由於機芯構造，在按摩過程中，確有可能感覺左右按摩輪的力度有差異。

為了能夠模擬出最自然的按摩手法，本品機芯採用了允許左右按摩輪交替捶背的機芯構造。在按摩過程中，左右按摩輪接觸背部的具體位置可能稍有差異，從而導致了使用者產生左右兩側按摩力度有所不同的感覺。此時，本品本身並未發生故障。

Q 使用本品時每個月耗電量是多少？

A 按每日30分鐘，使用頻率來計算，每月本品耗電量約為0.87度。

發生故障後，首先檢查並嘗試以下方法。
如果在嘗試後，故障依然存在，請聯繫銷售店。

| 問題 | 原因和處理方法 |
|----------------|---|
| 在使用本機過程中按摩輪停止 | <p>在使用過程中，按摩輪遇到過大的外力時，出於安全考慮，按摩輪可能會停止移動。</p> <p>如果按摩輪再次停止，請調整自己的坐姿，不要使背部完全貼在靠背上。（應注意遵守相關注意事項，尤其是體重在100kg或以上的人使用時。）</p> |
| 左右按摩輪的高度（強度）不同 | <p>因為搭載了可進行按摩輪交互捶拍動作的按摩機芯，出現這種情況純屬自然，並非機體故障。</p> |
| 本機根本無法運行 | <ul style="list-style-type: none"> ● 電源線連接已斷開。 ● 沒有打開本機電源開關。 ● 按下控制器上的開機鍵按鈕後，沒有選擇任何程式。 |
| 本機已受損 | <p>為防止事故發生，請務必與授權服務中心聯繫。</p> |
| 電源線或電源插頭異常發熱 | |

若以上處理方法無效，請聯繫ITSU服務中心。

關於運行過程中本機發出的聲音和令人在意的感覺

在使用中會發生下述動作音、感覺，不過這是因按摩椅的結構而發生的，並非異常。

- 動作時按摩輪擦過面料上的皺紋時發出的聲音和感覺
- 揉按、捶拍動作等的動作音
- 按摩輪動作時的摩擦聲
- 上下動作時的動作音
- 傳送帶的轉動音
- 電機音
- 落座時的聲音
- 靠背傾斜時扶手與靠墊的摩擦聲
- 按摩輪與布料的摩擦聲
- 氣囊按摩運作時的充氣泵工作音
- 氣囊按摩運作時的排氣音
- 氣囊按摩運作時座椅下電磁閥發出的工作音
- 腳置台的晃動
- 肩部伸展、動作時的聲音
- 氣囊的動作音
- 靠背傾斜時，靠墊與後蓋上皮革摩擦時發出的聲音

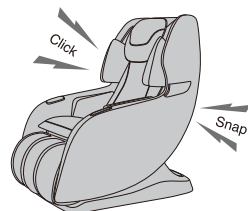

當聲音變大時，也有可能發生了故障。

- 此時，請委託授權服務中心進行檢查和修理。

警告

- 請勿擅自改造本機。請勿自行分解或修理本機。否則可能導致起火、異常動作、人身傷害。

警告

- 發生異常、故障時，立即停止使用，拔掉電源插頭。（否則可能冒煙、起火、觸電）
- <異常、故障事例>
- 接通電源開關後可能不動作
- 移動電源線，有時通電有時不通電
- 運行中發出焦臭味、異常聲響
- 按摩椅變形或者異常發熱
- 請立即委託授權服務中心檢查和修理。

| | |
|----------------------|--------------------|
| 電 源 | 220-240V~, 50/60Hz |
| 消 耗 電 力 | 65W |
| 尺 未 傾 斜 時 (長X寬X高) | 107.5cmx66cmx109cm |
| 重 量 | 約56kg |
| 包 裝 箱 尺 寸 (長X寬X高) | 116cmx73.5cmx116cm |
| 重 量 (含 包 裝 箱) | 約65kg |
| 用 戶 最 大 體 重 | 90kg |

對於體重90kg或以上的人士，產品運作時可能產生更大的噪聲而且面料外置可能磨損得更快。

規格

聯絡我們

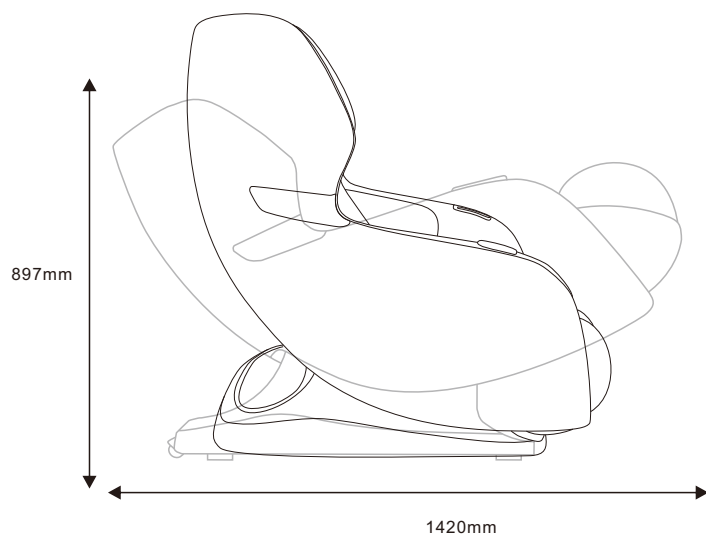
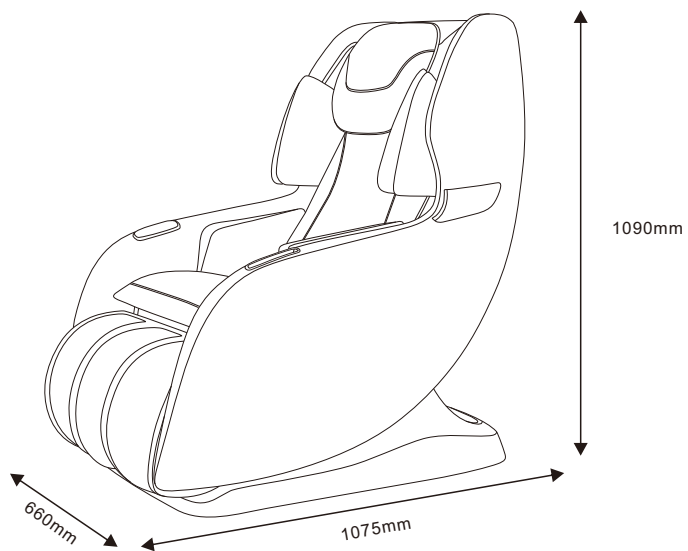

SC 22

SC 23



ITSU World Sdn Bhd
13 Lorong Teknologi B. Nouvelle Industry Park.
Taman Sains SG1 Kota Damansara. PJU 5.
47810 Petaling Jaya
Malaysia
Tel: +603 6732 3722



ITSU World(HK) Limited
Workshop D1,28/F. TML Tower
No. 3 Hoi Shing Road, Tsuen Wan, N.T.
Tel: +852 3611 2228



PT Healthy World
Lodan Center Block O No 20
Jalan Lodan Raya No 2
Jakarta Utara 14430
Tel: +62 21-6983 1123