

ITSU
御手の物®



Rev.1.0

User Manual
IS0601 使用説明書



User Manual

All information is correct at the time of printing

Thank you for purchasing ITSU product.

Please read the Safety Precautions carefully before use. The Safety Precautions are divided into warnings' and 'attention' in terms of the degree of danger. This book should be kept available for future reference after reading.

Contents

| | |
|-----------------------------|----|
| Safety Instructions | 2 |
| Warranty Claim | 4 |
| Product Parts | 5 |
| Product Operation Guide | 6 |
| Installation Guide | 9 |
| How to use | 10 |
| Product Operation Guide | 13 |
| Product Maintenance | 15 |
| Common Problems & Solutions | 18 |
| Product Specifications | 19 |
| Contact US | 20 |

Safety Instructions

Before operating the unit, please read all instructions carefully.

Make sure that the product is connected to a dedicated electric outlet for 220-240Vac, 50 Hz/60Hz.

Electricity Safety

- Do not handle the power plug or electric outlet with wet hands.
- Do not use a damaged power cord or plug.
- Plug in the power plug properly to operate the product.
- Do not attempt to disassemble or repair any electronic parts of the product.
- Do not spill water or liquids on the product.
- Do not use the product in a damp or humid environment.

Operation Safety

- Do not use the product near heating areas or on top of a heating surface.
- Do not use the product if you are experiencing health complications or conditions as stated below:
 - Suffering from heart diseases, malignant tumors, back pain, spine disorders, osteoporosis, high blood pressure and knee joint degeneration.
 - Pregnant or menstruating
 - Feeling unwell, fever, having inflammation, bruises and sensory impairment.

Others

- When there is a power outage, carefully unplug the product.
- If the product functions abnormally, immediately turn off the power, disconnect the power plug and contact our service centre.
- If you feel unwell or experience any discomfort while using the product, stop using it immediately.
- Close supervision is necessary when the product is near children, infants, or disabled persons.
- Do not insert your hand or foot into any openings of the product.
- The product is intended for use of one person each time.
- Standing mat is made from conductive carbon material, it is normal to observe tiny black powder residue after used.

Safety Instructions

Warning

- Do not fall asleep while using the product.
- Do not use the unit after drinking alcohol.
- Suggested usage time is 20 minutes, please rest for 30min before use it again.
- if you feel unwell or sick, Please stop immediately.
- Please follow the instructions accordingly while using the unit.
- While the product is in use, do not insert your hands into the space on the two sides of the product.
- Children should be supervised to ensure that they do not play with the product.



Use caution when handling the product, as some parts may contain sharp edges or protrusions that could cause injury if not observed.



Correct Disposal of this product

This marking indicates that this product should not be disposed with other household wastes. To prevent possible harm to the environment or human health from uncontrolled waste disposal, recycle it responsibly to promote the sustainable reuse of material resources.



Caution: read this user manual carefully before use.

Warranty Claim

1. Warranty is not transferable.
2. This warranty is effective only if the product is purchased from ITSU or any authorized distributors.
3. Proof of purchase (original receipt) is required for all warranty repairs.
4. All implied warranties, including but not limited to these implied warranties of fitness and merchantability, are limited to the duration stated in the warranty policy.
5. Damage due to misuse, improper treatment and unauthorized modification and repairs are not covered by this warranty.
6. Warranty does not cover accessories and add-ons, which do not belong to the product.
7. Warranty is not effective to rental, business, commercial, institutional, or other non-residential users.
8. All services covered by this warranty must be approved by ITSU and repaired by authorized technicians only.
9. If replacement parts for defective materials are not available, ITSU reserves the right to make substitutions in lieu of repair or replacement.

Product Parts

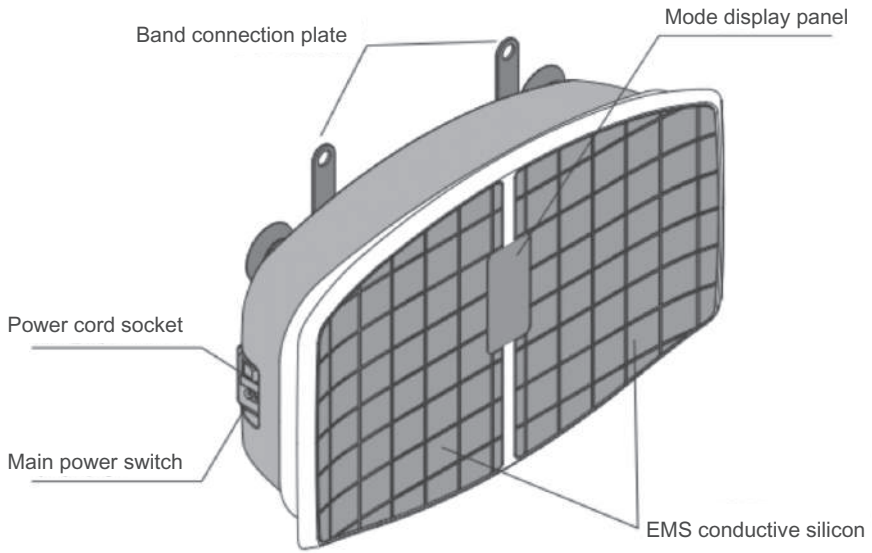

Elastic Band

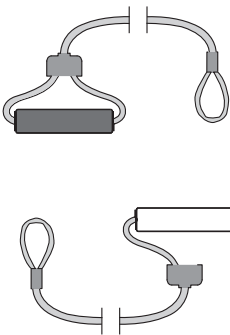

Remote controller

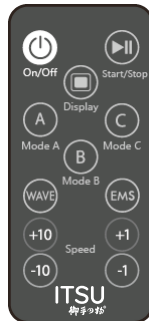

Lithium battery (for trial)

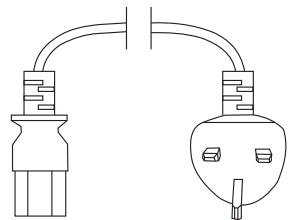

Power cord



Product Operation Guide



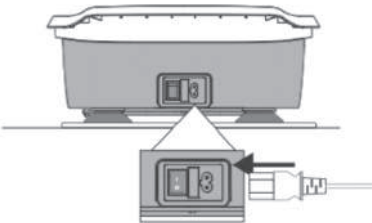
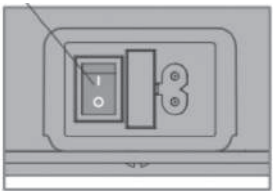

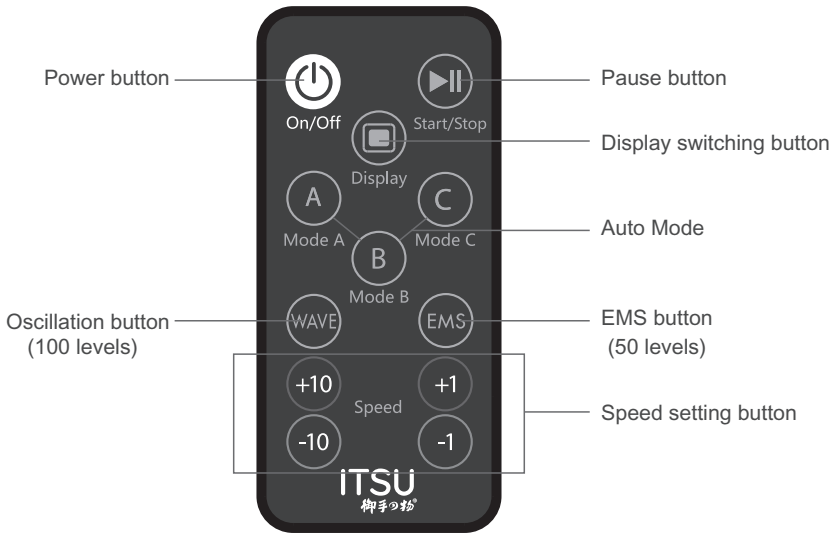

Please check before use

The product is for 220-240Vac, 50 Hz/60Hz.

| | |
|---|---|
|  | <p>1. Connect the power cord to the host. Insert the power cord into the power cord socket on the side of the host.</p> |
|  | <p>2. Turn on the main power Place the main power switch of the host on the "I" side and beep.</p> |
|  | <p>3. Remove the insulation sheet before using remote controller.</p> |
|  | <p>4. Tear off the protective film.</p> |



Product Operation Guide



| | |
|---|--|
|  <p>Please refer to page 6 for the first time to remove the insulation paper. If the insulation is retained, the power supply will not be turned on.</p> | <p>Turn on the power</p> <p>Press the power button to turn on the power.</p> <p>* you cannot turn on the power just by turning on the power to the main engine. Be sure to press the "power button" on the remote control.</p> |
| <div style="display: flex; justify-content: space-around; align-items: center;"> <div style="text-align: center;">  EMS manual mode  ▶▶ Mode </div> <div style="text-align: center;">  Oscillation manual mode  ▶▶ Mode </div> <div style="text-align: center;">  ▶▶ Mode </div> </div> <p>Operation starts immediately after each button is pressed.</p> | <p>Start the program</p> <p>Simply press any button and the set program mode will start immediately.</p> <p>* EMS/manual vibration mode starts at running speed 1.</p> |

Product Operation Guide

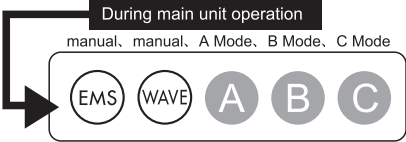
Common to all modes
*** Automatically stops in about 10 minutes**

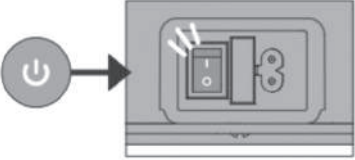
| | |
|---|--|
|  | <p>Stop the program If you want to stop in the middle You can pause/resume the operation by pressing the pause button.</p> |
|  | <p>If you want to change the program en route You can change the program by pressing any mode button during operation.</p> |
|  | <p>If you need to stop urgently You can stop it by pressing the "power button"</p> |
|  | <p>Finish Press the "power button" to stop the operation and place the main power switch on the "O" side to turn off the main power. Unplug the power cord from the main machine and save it.</p> |

Installation Guide

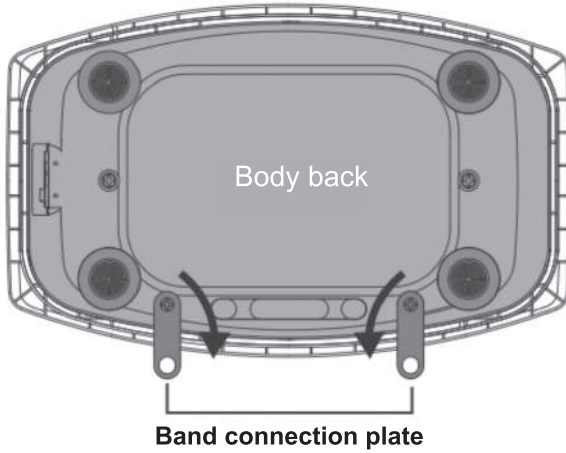

Rotate the tape connector on the back of the main engine and pull it out as shown in the figure above.

RESISTANCE BANDS

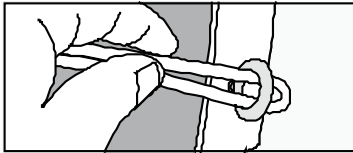

A

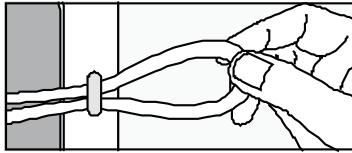

B

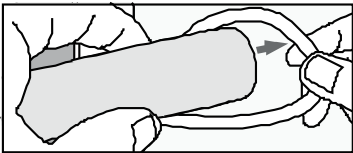

C

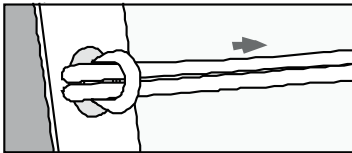



D

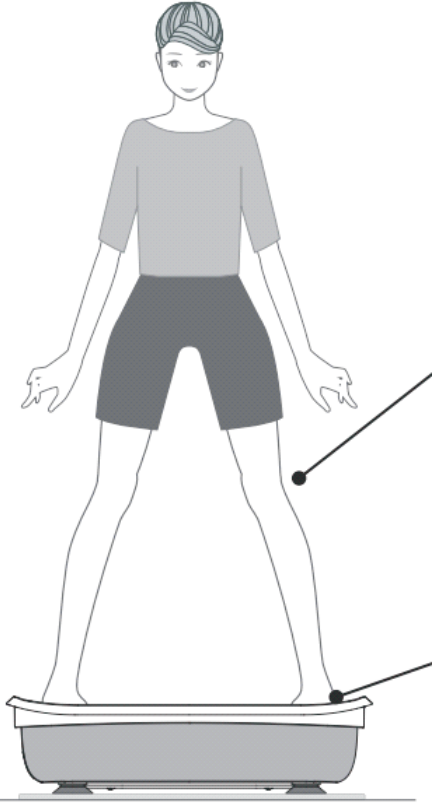

- Be sure to connect it when the power is off.
- Don't push too hard.
- Don't pull hard.

How to use

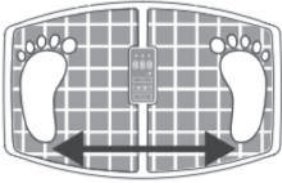
| | | |
|--|---|---|
|  <p>The illustration shows a person standing on a board. A line points to the knee area, and another line points to the feet on the board.</p> | <p>The basic position Spread your feet to shoulder width, bend your knees slightly, and stand on the board.</p> | |
| |  <p>A close-up diagram of a knee joint with a curved arrow pointing downwards, indicating the direction of knee flexion.</p> | <p>You can apply more load by bending your knees deeper.</p> |
| |  <p>A diagram showing two footprints on a grid. A double-headed arrow below the footprints indicates the width between them.</p> | <p>Opening the posture outwards places a heavy burden on the abdomen.</p> |

How to use

Area where load is applied



Abs and waist

Sit on the board and lower your upper body gently back. Raise your feet slightly so they don't touch the floor.

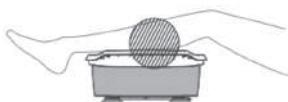

Calf

Place your calf on the board, lying on your back.



Waist, spine, hip

Put the board on the chair and sit upright with your back and your feet on the floor.

※ in EMS mode, please use it in the buttock tight state.

※ the chair may be damaged depending on the vibration level and usage. Please be careful not to get hurt. In addition, chair damage is not covered by the warranty.



Thigh/calf

Place your legs straight on the board in a chair position.



Thigh

With your arms extended forward, drop your waist down firmly.



Upper arm

Place your knees on the floor and then on the board so that your arms are perpendicular.

How to use

You can exercise your upper body at the same time by pulling the e-band or keeping it in the lifting position.

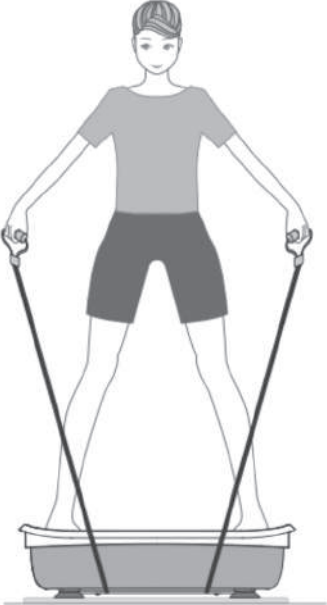
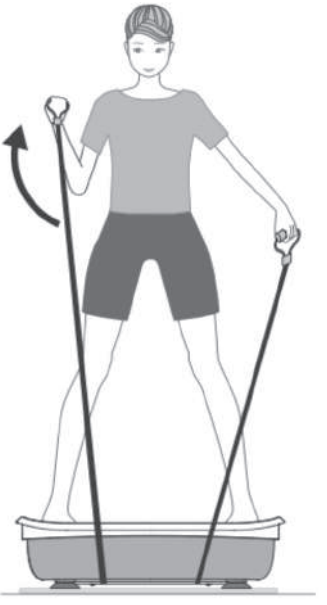
| | |
|--|---|
|  |  |
| <p>The basic position Stand on the board with your feet shoulder-width apart as you pull the band.</p> | <p>Upper arm tightened Pull up the band you want to train vertically. Training the biceps to tighten the upper arm.</p> |

Product Operation Guide

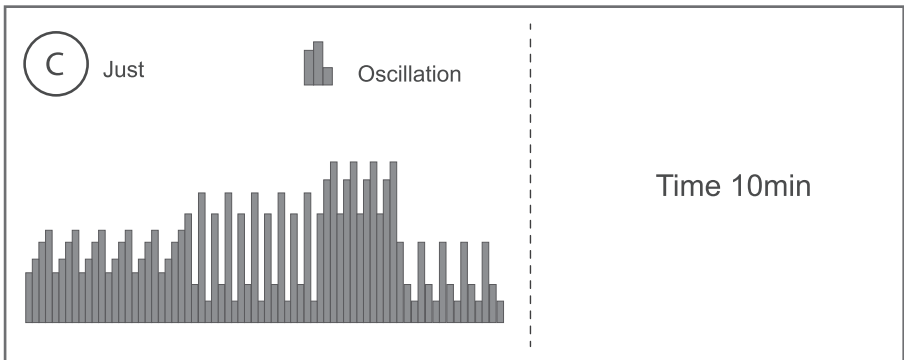
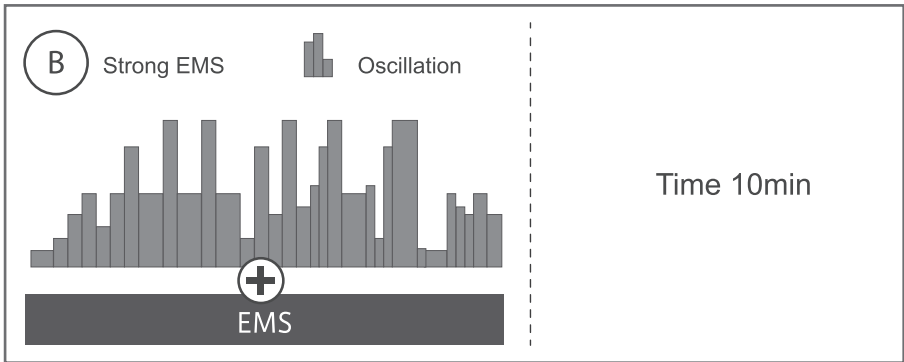
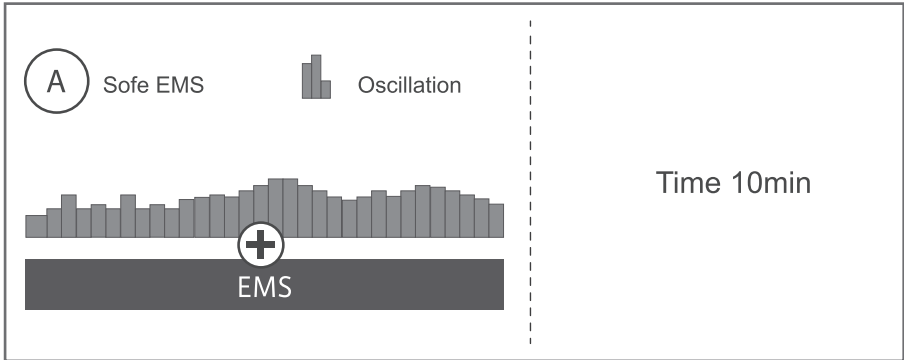

Product Operation Guide

There is a mode display panel in the center of the host to show the operation status, and you can check the mode used, output and calorie consumption.

| | |
|--|---|
| | <p>① Output/calorie display Displays the output of the selected mode and the calories burned at the end of that mode.</p> |
| | <p>② EMS mode display You can choose by pressing the button on the remote control.</p> |
| | <p>③ Oscillation mode display You can choose by pressing the button on the remote control.</p> |

| A mode selection | B mode selection | C mode selection | <p>④ Automatic mode display Press the desired button on the remote control a-b-c to start the selected mode. The current selected mode on the output/ calorie display can be confirmed by the LED mode light.</p> |
|----------------------------|--|-----------------------------|---|
| | | | |
| The upper left LED lights. | The LED in the upper center lights up. | The upper right LED lights. | |

Product Maintenance

- If the product was stored in a cold place for a period of time, it is suggested to wait one hour before usage.
- If the product is going to be placed in a special environment, such as salty or sulfurous area, please contact our service center for protection to prevent malfunction.

Always unplug the unit before cleaning it.

Please do not use thinner, benzene or alcohol to clean the unit.

Use dry cloth to thoroughly clean the product, do not wipe with wet cloth.

Do not place the product near heaters, or exposed to heat resources or direct sunlight.

- If you may not use the product for a period of time, it is suggested to unplug the unit and store it well under a clean and dry environment.
- Do not eat or drink on the product, to prevent malfunction.
- Storage environment :Temperature-10°C~55°C, Humidity RH0~85%

Product Maintenance

※When cleaning, be sure to turn off the power and unplug the power cord from the socket.

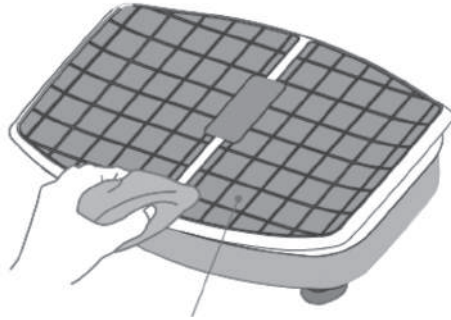

Wipe dirt with a dry, soft cloth.

※ if the dirt is serious, please put the diluted neutral detergent in the rough cloth, wring it out and then wipe it. After that, please wipe it with a dry cloth.



Be sure to clean the remote with a dry cloth, as cleaning the remote with a wet cloth may cause malfunction.

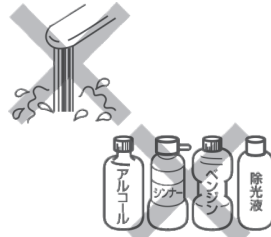

Do not clean the equipment with water. Do not use diluent, benzene, alcohol, remover and other organic solvents to clean the host. Otherwise it may fade, corrode and crack.









Product Maintenance

Please store this product in the following places

| | | |
|---|---|--|
|  |  | <p>Temperature 10 ~35 °C Humidity: 20 ~80%</p> |
| <p>Horizontal and stable place</p> | <p>Ventilated area</p> | <p>Above temperature and humidity location</p> |

Please do not store this product in the following places

The device is made of sophisticated mechanical and electronic components. Avoid installing the machine in the following places, which may cause a failure.

| | | |
|--|--|---|
|  <p>Places exposed to direct sunlight</p> |  <p>Places with a lot of dust</p> |  <p>Places where temperature changes rapidly</p> |
|  <p>Places where the humidity changes drastically</p> |  <p>Places with fire</p> |  <p>Places that are easily wet by water</p> |
|  <p>Places with volatile substances</p> |  <p>Places close to cooling and heating equipment</p> |  <p>Places with vibration</p> |



Caution

Do not use it on infants or people who cannot express their intentions, and do not keep it within easy reach. Otherwise it could lead to an accident or poor health.

Common Problems & Solutions:

| | | | |
|-----|--|-----|---|
| Q1 | Does not work when power is turned on | Q5 | Can it be used in the bathroom? |
| A | Check that the power cord is connected to both the host and socket. Check whether the main power switch is on. Check the operation panel or remote control is not working. * if only the remote control does not work, please replace the battery, because the remote control battery may be dead. | A | This product is not waterproof. Please do not use it in the bathroom as it may cause trouble. |
| | | Q6 | Can it be used outdoors? |
| | | A | Don't use it. Please do not use it outdoors as it may cause trouble. |
| Q2 | Suddenly stopped | Q7 | Can I use it during pregnancy or right after giving birth? |
| A | Check that the power cord is connected to both the host and socket. | A | Please do not use. For postpartum and lactating persons, consult a physician who frequently visits the clinic. |
| Q3 | Make noise | Q8 | Is there a weight limit? |
| A | Be sure to install it in a flat and stable place. The structure of the product produces some operational noise, so it is not an anomaly in this case. If the noise is heard inside the product, foreign body may be mixed in due to damage or other reasons. Please contact the customer service window on page 00. | A | The load capacity of the product is 100kg. Do not use if the load capacity is exceeded. |
| | | Q9 | Remote control does not respond |
| | | A | Please replace the battery of the remote control. Other reasons may be the remote location of the product and remote control, not suitable for display panel. Please aim the remote control at the display panel and operate within a distance of 1.5m. |
| Q4 | Can I use it every day? | Q10 | I lost my remote |
| A | No problem but only use it three times a day (30 minutes) at most. Overuse can lead to accidents, such as injuries. | A | Consult your dealer. |
| Q11 | I don't know where to attach the band | Q16 | Stuck, unable to operate |
| A | On the back of the main frame there is a connecting plate for the upper body band. Please refer to page 9 for details. | A | Replace the battery of the remote control and check the operation of this product again. In addition, the product is designed to stop automatically 10 minutes after use, either automatically or manually. |
| Q12 | I want to attach the ground terminal, but there is no mounting hole at home | Q17 | Strong current, feel pain |
| A | After consulting with a dealer or electrical construction shop, we recommend ground installation work (class D < type 3 > installation work). | A | The output setting may be too high. Try adjusting the output using the remote control. In addition, EMS mode is used only once a day. |
| Q13 | Weak stimulation in EMS mode | | |
| A | Output Settings may be low. Adjust the output with the remote control. | | |
| Q14 | I feel the stimulus is different on the left and right | | |
| A | If only one foot is wet, or if you use a moisturizer, the current experience will be different. Please do not use this product until you have thoroughly wiped your feet. Also, even if only one leg has a scratch or cut, the body will feel different. Do not use this product until the wound is completely healed. | | |
| Q15 | Warning sound does not stop * Manual (EMS mode) | | |
| A | Due to dry skin, the current may not flow easily. Please use again when the contact surface is wet | | |

Product Specifications

| | |
|-----------------------------|--|
| Voltage | 220 – 240Vac, 50/60Hz |
| Rated power | 200W |
| Model | IS0601 |
| Size | W430mm × D290mm × H130mm |
| Weight | Approx 8.3kg |
| Remote control power supply | CR2025 lithium battery |
| Material | Body: ABS resin, PVC resin, rubber Remote control: ABS resin, PVC resin Special mat: TPE |
| Maximum adaptive weight | 100 kg |

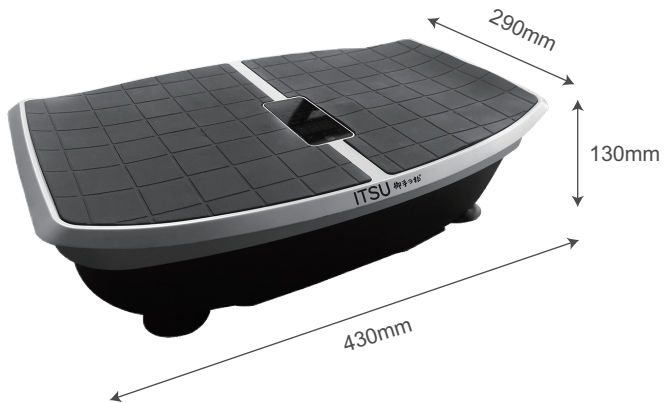

Contact Us



ITSU World Sdn Bhd
13 Lorong Teknologi B. Nouvelle Industry Park.
Taman Sains SG1 Kota Damansara. PJU 5.
47810 Petaling Jaya
Malaysia
Tel: +603 6732 3722



ITSU World(HK) Limited
Workshop D1,28/F. TML Tower
No. 3 Hoi Shing Road, Tsuen Wan, N.T.
Tel: +852 3611 2228



PT Healthy World
Lodan Center Block O No 20
Jalan Lodan Raya No 2
Jakarta Utara 14430
Tel: +62 21-6983 1123

目錄

| | |
|------|----|
| 安全指引 | 23 |
| 保修權限 | 26 |
| 產品配件 | 27 |
| 操作指南 | 28 |
| 安裝指南 | 31 |
| 運動指南 | 32 |
| 操作指南 | 35 |
| 產品保養 | 37 |
| 常見問題 | 40 |
| 產品規格 | 41 |
| 聯絡我們 | 42 |

感谢您购买ITSU的产品。

使用足底按摩器前请仔细阅读安全注意事项。安全措施根据危险程度分为“警告”和“注意”。这本书应保存起来，以备以后阅读时参考。

安全指引

請在使用產品之前詳細閱讀此使用說明

本產品僅使用 220-240Vac, 50Hz/60Hz 的電源。

電器安全

- 雙手或雙腳沾溼時，切勿觸碰插座上之插頭
- 如遇本產品電源線脫落或表面破損、龜裂，切勿使用。
- 請將插頭完整插入插座後方使用。
- 不可試圖自行拆卸或修理本產品，本產品僅能由維修人員保養修理。
- 請勿將本產品浸泡。
- 請勿在濕氣過重之處使用本產品。

操作安全

以下人士，請在使用前先諮詢醫生的意見：

- 心臟病患者、惡性腫瘤患者、背痛、脊椎側彎或異常、高血壓、骨質疏松症等。
- 孕婦或月經期間
- 身體不適者、發燒、身體有紅腫或發炎、瘀青、過敏等。

其他事項

- 使用本產品時若逢停電，請立即拔除插頭。
- 當本產品操作異常時，請迅速關閉電源開關拔除插頭，並通知維修人員進行檢查，修繕。
- 在您使用本產品期間若感到任何不適，請立即停止操作。
- 孩童或行動不便者位處本產品周圍時，務必由成人在旁監督。
- 勿將手、腳插入按摩機構間隙。
- 本產品每次僅限一人使用。

安全指引

注意事項

- 逢電源插上及本產品作動時，勿將其留置無人看管。
- 請由插頭處插入或拔除插頭，不可隨意拉扯電源線。
- 切勿將異物插入機構間隙內。
- 坐本機時必須坐立中間點，避免單邊重力施壓。
- 請在平坦之地面使用本產品。
- 本產品僅限於室內使用。
- 體重超過100公斤有機會加速機件耗損。
- 墊子材質有包括碳粉，如有黑色粉末掉落屬為正常現象。

警告

- 請勿在打盹時使用本產品
- 酒醉者請勿使用本產品
- 每次使用10分鐘為準，視乎個人體質而決定時間
- 請務必依循本手冊所述使用本產品
- 使用時勿將手、腳插入按摩機構間隙
- 應監管兒童以確保他們不會玩耍本產品

安全指引



使用時要小心處理產品，部分零件可能含有鋒利的邊緣或突出物，若疏忽可能會導致受傷。



處理此器材的正確方法

本標誌表示此產品皆不可與家庭廢棄物一同丟棄。為避免任意丟棄對環境與人體健康可能造成的傷害，應增加回收後可利用物質的再使用性。

歸還使用過器具，請遵循歸還及回收程序，或與原購買零售商聯繫。

他們能將產品進行對環境安全的回收。



警告：使用前仔細閱讀此說明書。

保修权限

1. 本保修权限不得轉讓於其他人或產品
2. 本保修服務僅有效餘ITSU或其授權代理購買產品
3. 當要求保修服務時，請出示正本購買收據。
4. 保修範圍內的維修服務自購買日起有效，期限需視各國的保修政策而定。
5. 由於錯誤的使用，不適當保養以及未經授權私自改裝和維修產品而導致的損壞，不屬於保修範圍。
6. 此保修範圍不包括不屬於產品本身的附件。
7. 此保修範圍不適用於租憑交易，商業機構或其他非居民使用者。
8. 此保修範圍內所涉及的維修服務需經過ITSU授權，且必須由授權的技術人員維修。
9. 若需更換的維修附件缺貨，ITSU有權採用替代配件進行維修。

产品配件

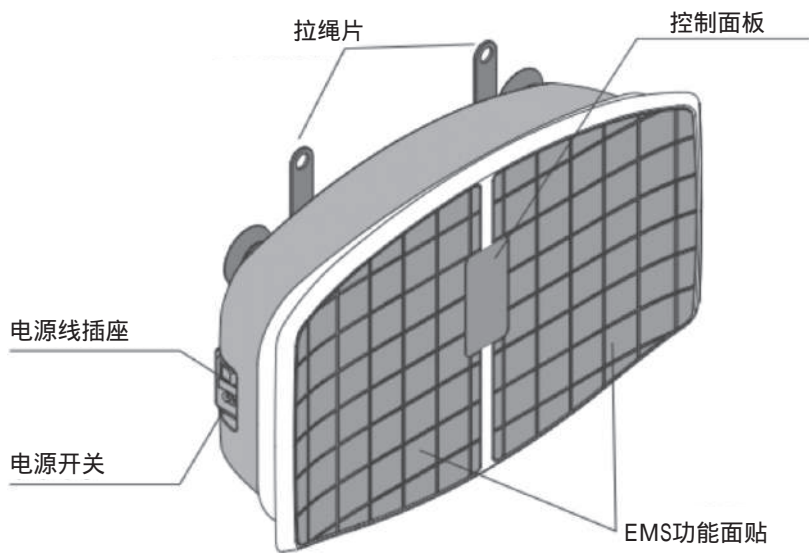

拉绳

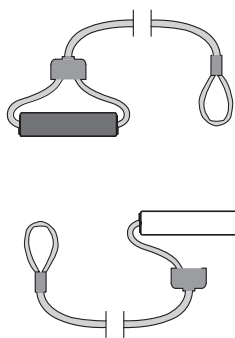

遥控器



电源线

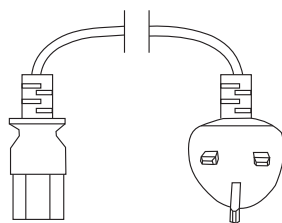



锂电池

操作指南

使用前请检查

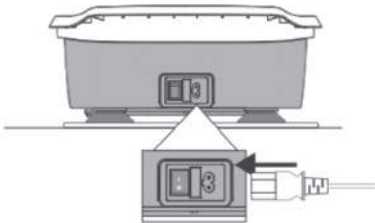
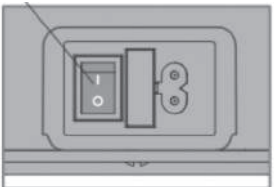
该产品适用于220-240Vac，50Hz/60Hz.

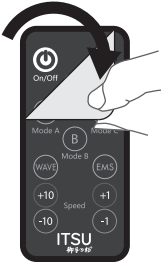
| | |
|---|---|
|  | <p>1.将电源线连接到主机。将电源线插入主机侧面的电源线插座。</p> |
|  | <p>2. 打开总电源将 主机的总电源开关置于“ I ”侧并发出哔声。</p> |
|  | <p>3.使用遥控器前先将绝缘片拔出。</p> |
|  | <p>4. 撕掉保护膜。</p> |



操作指南



| | |
|--|---|
|  <p>第一次取下绝缘纸请参考第28页。 如果绝缘片被保留，电源将不会被打开。</p> | <p>打开电源 按电源按钮打开电源。 *你不能仅仅通过打开主机电源就打开电源。一定要按遥控器上的电源按钮。</p> |
| <p>EMS 手动模式 甩脂手动模式</p> <p>A 模式 B 模式 C 模式</p> <p>按下每个按钮后，操作立即开始。</p> | <p>启动程序 只需按下任何按钮和设置程序模式将立即启动 * EMS/手动振动模式在运行速度下启动</p> |

操作指南

所有模式通用
*自动停止约10分钟

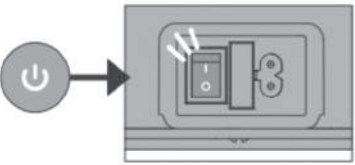
| | |
|--|---|
|  | <p>停止程序如果你想在中间停下来按下暂停键可以暂停/恢复操作。</p> |
|  | <p>如果你想中途改变计划在运行过程中，你可以通过按任何模式按钮来改变程序。</p> |
|  | <p>如果你需要紧急停车按下电源按钮就可以关机了。</p> |
|  | <p>完成 按下“电源按钮”停止操作，将总电源开关置于“ ”侧，关闭总电源。 从主机上拔下电源线并保存</p> |

安装指南

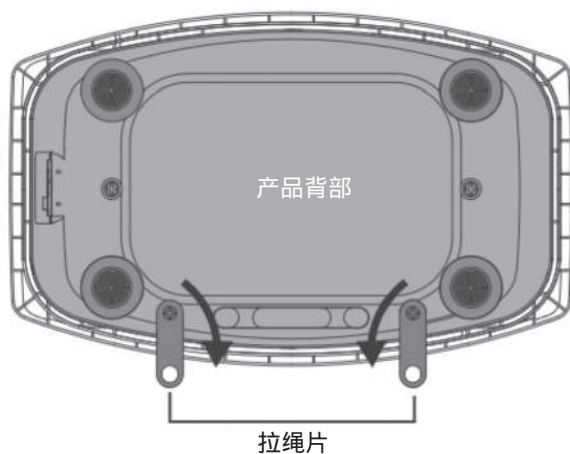

旋转主机后面的磁带连接器，如图所示将其拉出。

穿绳方式

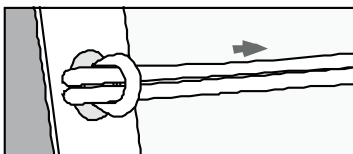
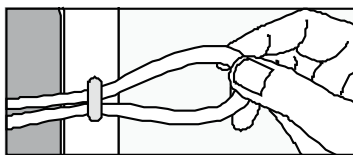
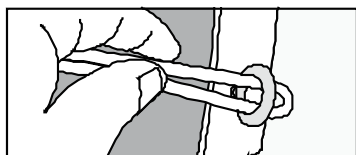

- 一定要在断电时把它接上。
- 不要逼得太紧。
- 不要硬拉。

运动指南

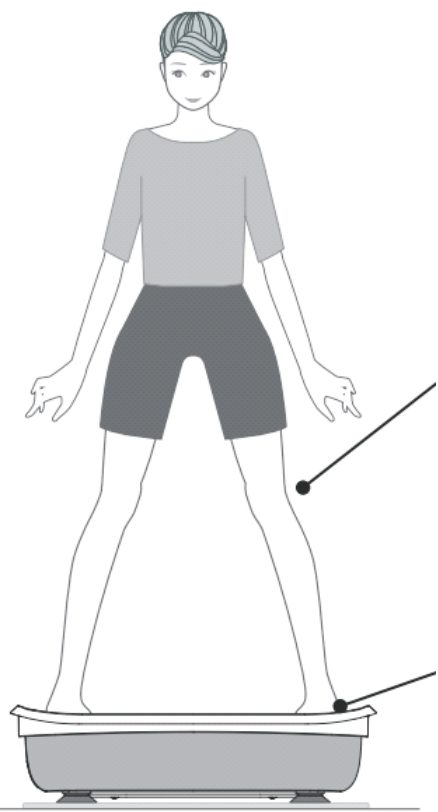
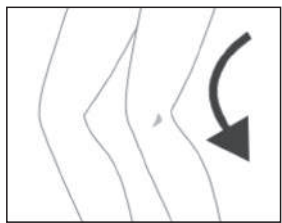
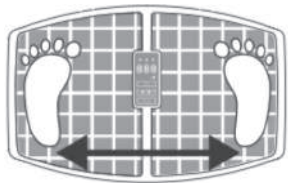
| | | |
|--|---|-------------------------------|
|  | <p>站立姿势 双脚与肩同宽，膝盖微微弯曲，站在跳板上。</p> | |
| |  | <p>你可以通过把膝盖弯曲得更深来施加更多的负荷。</p> |
| |  | <p>向外打开姿势会加重腹部的负担。</p> |

运动指南

负载应用的区域



腹肌和腰部坐在板上，把你的上半身慢慢放回背部。稍微抬起你的脚，这样它们就不会碰到地板。



大腿和小腿双腿伸直放在木板上，呈椅子状。

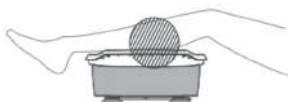

把小腿放在木板上，仰卧。



双臂向前伸展，腰部稳稳地垂下。



腰、脊椎、臀部把板子放在椅子上，背部挺直地坐着，双脚放在地板上。

EMS模式下，请在紧臀状态下使用。根据振动程度和使用情况，椅子可能会损坏。另外，椅子损坏不在保修范围内。拉动e带或保持e带在起吊位置，可以同时锻炼上半身。



上臂把你的膝盖放在地板上，然后放在板上，这样你的手臂是垂直的。

运动指南

拉动e带或保持e带在起吊位置，可以同时锻炼上半身。

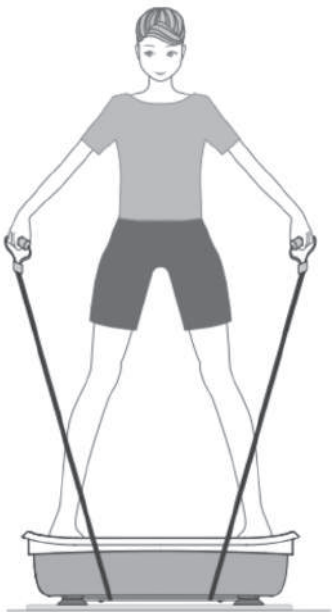
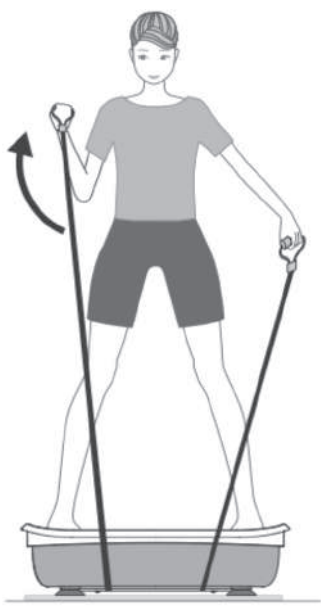
| | |
|---|---|
|  |  |
| <p>基础姿势 站在面板上，双脚与肩同宽，拉起拉带。</p> | <p>向上抬上臂 拉起你想垂直训练的带子。训练肱二头肌收紧上臂。</p> |

操作指南

(A) Safe EMS  甩脂



时间10分钟

(B) Strong EMS  甩脂

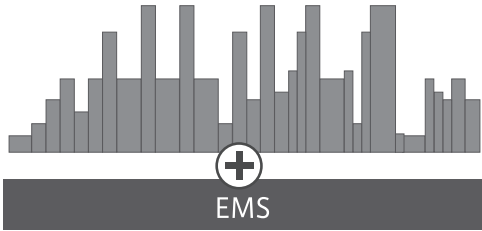

时间10分钟

(C) Just  甩脂

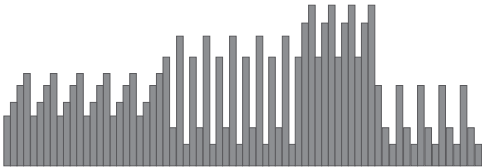





时间10分钟

操作指南

模式显示面板说明

主机中央有模式显示面板，显示运行状态，可查看所使用的模式，产出和热量消耗。

| | |
|---|--|
|  | <p>① 热量显示输 显示所选模式的输出以及最后消耗的卡路里模式。</p> |
| | <p>② EMS模式显示 您可以通过按遥控器上的按钮进行选择。</p> |
| | <p>③ 用脂模式显示 你可以按遥控器上的按钮进行选择。</p> |

| A 模式 | B 模式 | C 模式 | |
|---|---|---|--|
|  |  |  | <p>④ 自动模式显示 按遥控器a-b-c上所需的按钮，启动所选模式。通过LED模式灯可以确认输出/卡路里显示上当前选择的模式。</p> |
| <p>左上方LED灯亮。</p> | <p>上方中央的LED灯亮。</p> | <p>右上方LED灯亮。</p> | |

产品保养

- 如果您的產品因運送、搬移或其他原因而曾置在低溫的環境下過久，請待置於室溫一小時方開機使用。
- 若欲將本產品置於特殊環境如：易受鹽分、硫磺等物質侵蝕的地區，敬請事先告知安裝人員做好防護措施，否則將可能造成機體損壞。
- 清潔保養本產品時，請先自插座取下插頭
- 請勿以苯類、稀釋劑或任何侵蝕性溶劑擦拭本機。
- 請僅使用乾布擦拭本機，切勿用濕布。
- 切勿將本產品長期暴露於陽光直射處，亦不可擺放接近於火源、高溫處。
- 若您將有一段時日部會使用到本產品，建議將電源線拔除後整齊捲好，並儲放本產品於較無塵且乾燥空間。
- 切勿在產品上飲食、以防不慎傷害到本產品。
- 儲存環境為：攝氏-10 C ~ 55 C，濕度為RH 0~85%

产品保养

清洗时，一定要关掉电源，从插座上拔下电源线。

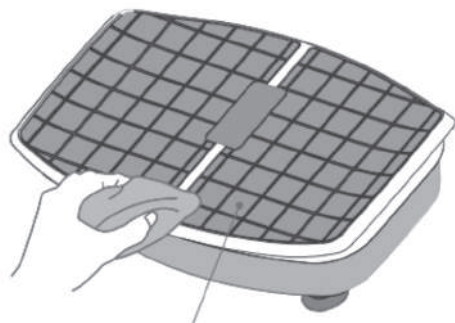

用干燥的软布擦拭污垢。

如污垢严重，请将稀释后的中性洗涤剂放在粗糙的抹布上，拧干后再擦拭

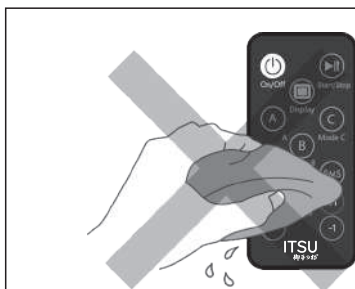

一定要用一块干布清洁遥控器，作为清洁。使用湿布的遥控器可能导致故障。

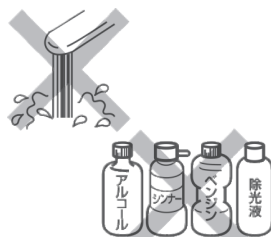

请勿用水清洗设备。不要使用稀释剂、苯。用酒精、去污剂等有机溶剂清洗主机。否则，它可能会褪色、腐蚀和开裂。

产品保养

请将本产品存放在以下地方。

| | | |
|---|---|------------------------|
|  |  | 温度10 ~35 湿度:20 ~80% |
| 水平稳定处 | 通风地方 | 温度和湿度在以上范围的地方 |

请不要将本产品存放在以下地方

这个装置是由精密的机械和电子元件组成的。避免将机器安装在以下位置，以免造成故障。

| | | |
|--|--|--|
|  <p>暴露在阳光直射下的地方</p> |  <p>有很多灰尘的地方</p> |  <p>温度变化迅速的地方</p> |
|  <p>湿度变化剧烈的地方</p> |  <p>用火的地方</p> |  <p>容易被水弄湿的地方</p> |
|  <p>有挥发性物质的地方</p> |  <p>靠近冷却、加热、设备的地方</p> |  <p>振动的地方</p> |

注意

不要用在婴儿或不能表达自己意图的人身上，也不要把它放在触手可及的地方。否则，它可能会导致事故或健康状况恶化。

常见问题及解决方案：

| | | | |
|-----|---|-----|---|
| Q1 | 当电源打开时不工作 | Q5 | 可以在浴室使用吗? |
| A | 检查电源线是否连接到主机和插座上。检查总电源开关是否打开。检查操作面板或遥控器不工作。*如果只有遥控器不工作,请更换电池,因为遥控器电池可能已经没电了。 | A | 本产品不防水。请不要在浴室使用它,因为它可能会给我带来麻烦。 |
| | | Q6 | 可以在户外使用吗? |
| | | A | 不要使用它。请不要在户外使用,否则会造成麻烦。 |
| Q2 | 突然停止 | Q7 | 我可以在怀孕期间或产后使用它吗? |
| A | 检查电源线是否连接到主机和插座上。 | A | 请不要使用。对于产后和哺乳期的人,请向经常到诊所就诊的医生咨询。 |
| Q3 | 有异音 | Q8 | 有重量限制吗? |
| A | 请务必将其安装在平坦、稳定的地方。产品的结构会产生一些操作噪音,所以在这种情况下它不是异常。如果在产品内部听到噪音,可能由于损坏或其他原因有异物混入。请联系第00页的客户服务窗口。 | A | 产品的承载能力为100kg。如果超过了负载能力,请不要使用。 |
| | | Q9 | 遥控器没有反应 |
| | | A | 请更换遥控器的电池。其他原因可能是产品位置和遥控器远,不适合显示面板。请将遥控器对准显示屏,在1.5米范围内操作。 |
| Q4 | 我可以每天都用吗? | Q10 | 遥控器弄丢了 |
| A | 没问题,但一天最多只用三次(30分钟)。过度使用会导致意外,例如受伤。 | A | 咨询你的经销商。 |
| Q11 | 不知道该怎么把拉绳系在哪里 | Q16 | 卡住了,无法操作 |
| A | 在主架的背面有用于上体带的连接板。详情请参阅第31页。 | A | 更换遥控器电池,并再次检查本产品的使用情况。此外,本产品设计在使用后10分钟自动停止,自动或手动。 |
| Q12 | 想接上接地端子,但家里没有安装孔 | Q17 | 强电流,感觉疼痛 |
| A | 经咨询经销商或电气施工车间,建议进行地面安装工程(D类< 3型>安装工程)。 | A | 输出设置可能过高。试着用遥控器调节输出。另外,EMS模式每天只使用一次。 |
| Q13 | EMS模式弱刺激 | | |
| A | 输出设置可能偏低。用遥控器调节输出。 | | |
| Q14 | 觉得左右两边的刺激不同 | | |
| A | 如果只有一只脚是湿的,或者你用了保湿霜,现在的体验就会不同。请不要使用本产品,直到您彻底擦拭您的脚。而且,即使只有一条腿有划痕或划伤,身体也会有不同的感觉。在伤口完全愈合之前不要使用本产品。 | | |
| Q15 | 警告声不停 手册(EMS模式) | | |
| A | 由于皮肤干燥,电流可能不容易流动。接触面湿后请再次使用 | | |

产品规格

| | |
|--------|---|
| 额定电压 | 220 - 240Vac, 50/60Hz |
| 额定功率 | 200W |
| 型号 | IS0601 |
| 尺寸 | W430mm × D290mm × H130mm |
| 重量 | 约 8.3kg |
| 远程控制电源 | CR2025 lithium battery |
| 成分主体 | ABS树脂、PVC树脂、橡胶，遥控:ABS树脂、PVC树脂，特殊的垫子:TPE |
| 最大承重量 | 100 kg |

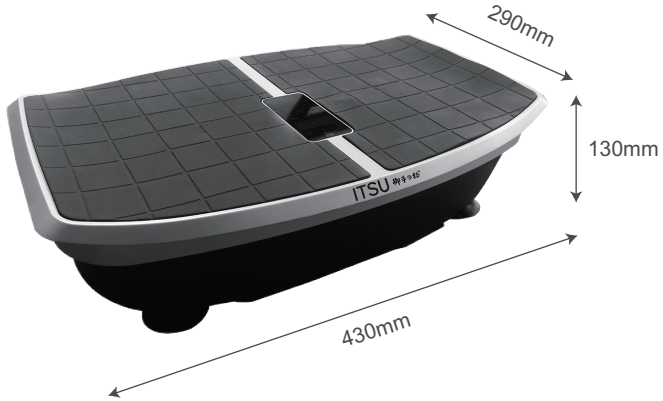

聯絡我們

馬來西亞



ITSU World Sdn Bhd
13 Lorong Teknologi B. Nouvelle Industry Park.
Taman Sains SG1 Kota Damansara. PJU 5.
47810 Petaling Jaya
Malaysia
Tel: +603 6732 3722



ITSU World(HK) Limited
Workshop D1,28/F. TML Tower
No. 3 Hoi Shing Road, Tsuen Wan, N.T.
Tel: +852 3611 2228



PT Healthy World
Lodan Center Block O No 20
Jalan Lodan Raya No 2
Jakarta Utara 14430
Tel: +62 21-6983 1123

ITSU
御手の物®